

# Öskuhaugsrannsóknir á Skútustöðum í Mývatnssveit 2008

## Framvinduskýrsla I



**Ritstjóri:** Ágústa Edwald

**Höfundar efnis:** Guðrún Alda Gísladóttir, Sigrid Juel Hansen, Elín Ósk Hreiðarsdóttir, Gavin Lucas, Megan T. Hicks, Thomas H. McGovern og Ramona Harrison.



Fornleifastofnun Íslands  
Reykjavík 2009  
FS419-08271

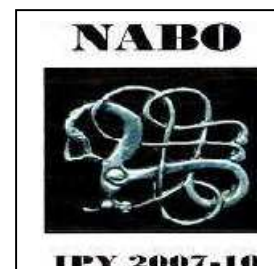

## Efnisyfirlit

Inngangur .....	4
Umfang og dýpt öskuhaugsins .....	5
Uppgraftarskurðir .....	9
Svæði D .....	9
Svæði E1 og E2.....	10
Svæði F.....	11
Finds.....	12
Discussion.....	14
Specific artefacts and ceramics .....	15
A Preliminary Report of the 2008 Midden Excavation at Skutustadir, N Iceland .....	18
Introduction .....	19
Excavation and Recovery .....	19
Laboratory Methods .....	21
Taphonomy .....	22
Subsistence.....	24
Acknowledgements .....	30
Fornleifaskóli barnanna .....	31
Niðurlag .....	31
Frekari rannsóknir.....	32
Heimildaskrá .....	33
Viðauki .....	35
Sniðteikningar.....	35

Jarðлага skrá (Context register):.....	38
Fundaskrá (Finds register):.....	42
Beinaskrá (Bone register):.....	49
Harris Matrix.....	51

## Listi yfir myndir og töflur

FIG 1: Teikning af Skútustöðum frá 1892	FIG 14: Mannvistarlag 063 á svæði E2
Fig 2: Yfirlitsmynd af uppgraftarsvæðinu	FIG 15: Svæði F, ný opnað
FIG 3: Graf I SKU08 110 line	FIG 16: Veggur 080 í skurði F
FIG 4: Graf II SKU08 103 line	FIG 17: Artefact <67> Clothing fastener
FIG 5: Graf III SKU08 505 line	FIG 18: Artefact <028> Copper alloy pin
FIG 6: Graf IV SKU08 510 line	FIG 19: Number of artefacts according to material
FIG 7: Svæði D, ný opnað	FIG 20: Artefact <029> Stone hammer
FIG 8: Svæði D eftir að uppgreftri var lokið	FIG 21: Artefact <075> Viking Age Bead
FIG 9: Snið í norðurhlið skurðs D	FIG 22: Burnt bone frequency throughout Skútustaðir
FIG 10: Svæði E1 áður en að hreinsun hófst	FIG 23: Cattle: Age at Death
FIG 11: Snið E1, horft til vesturs	FIG 24: Cattle vs. Caprines
FIG 12: Gjóskulagagreining í sniði E1	FIG 25: Extreme dental wear and pathology
FIG 13: Svæði E2	

TABLE 1: Number and percentage of finds according to material

TABLE 2: Ages and bone-bearing contexts at Skútustaðir 2008

TABLE 3: NISP in various size categories

TABLE 4: Gnawing by dogs (*Canis familiaris*)

TABLE 5: Jarðlagaskrá (Context register)

TABLE 6: Fundaskrá (Finds register)

TABLE 7: Beinaskrá (Bone register)

## Inngangur

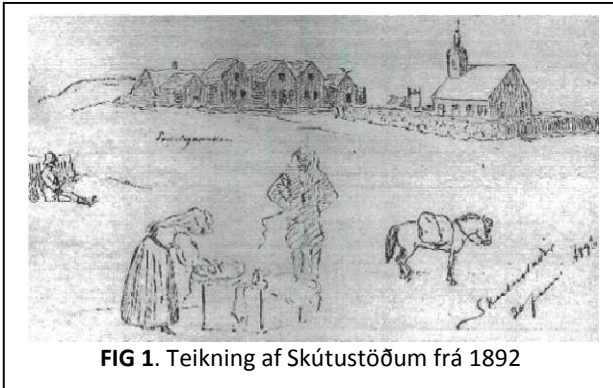

FIG 1. Teikning af Skútustöðum frá 1892

Dagana 22. júní – 4. Júlí var unnið að uppgreftri á öskuhaugi í bakgarði Skútustaða III. Uppgröfturinn er hluti af stóru alþjóðlegu verkefni sem lýtur að landnámi og byggð á Norðurlandi og hefur verið unnið að síðan 1996. Verkefið nefnist á ensku *The Landscapes of Settlement: Historical Ecology of the Colonization of Northern Iceland* (sammstafað LoS) og er sérstök áhersla lögð á

umhverfisvístfræði Mývatns og nágrennis sem er rannsökuð með hjálp sagnfræði- fornleifafræði og umhverfisvísinda.<sup>1</sup>

Sumarið 2007 voru tekin borkjarnasýni á lóð Skútustaða III sem bentu til þess að þar væri umfangsmikill öskuhaugur undir sverði og var það tilefni rannsókna sumarið 2008 þar sem áætlað var að meta umfang, dýpt og gerð öskuhaugsins auk þess að hefja uppgroft og safna dýrabeinum og gripum frá síðari notkunarskeiðum hans.

Að uppgreftrinum unnu: Ágústa Edwald (uppgraftarstjóri), Tomas H. McGovern, George Hambrecht, Frank Feeley, Véronique Forbes, Jennifer Brown, Aaron Kendall, Valerie DeFeu og Ian Simpson.

Gerður Benediktsdóttir ábúandi á Skútustöðum III veitti okkur hlýjar móttökur og ómetanlega aðstoð og eru henni færðar bestu þakkir fyrir sem og Árna Einarssyni á Náttúrurannsóknarstöðinni við Mývatn fyrir margvíslega aðstoð og greiðasemi.

Skútustaðir í Mývatnssveit er mjög forn jörð frá fyrstu tímum Íslandsbyggðar. Jarðarinnar er getið í Reykdælasögu þar sem Víga-Skúti er sagður hafa keypt sér land að Mývatni og og að hann búi þar sem heiti að Skútustöðum (ÍF X, 204). Jörðin er líklega með elstu jörðum við Mývatn og hefur fljótt orðið miðstöð jarðanna við sunnanvert vatnið. Skústaðir eru krikujörð og er elsti varðveitti máldagi krikjunnar frá 1318 (DII, 430). Jörðin skiptist nú í þrennt. Helmingur hennar tilheyrir Skútustöðum I, og fjórðungur hvorri Skútustöðum II og III.

Gamli bærin á Skútustöðum sem sést á teikningunni hér að ofan frá 1892 (Fig 1) var nálega á milli núverandi íbúðarhúsa á Skútustöðum II og III og sneri því sem næst norður-suður. Enginn eiginlegur bæjarhóll er á þeim stað, en íbúðarhúsið á Skútustöðum III stendur á talsverðum hól sem og austara

<sup>1</sup> Ágætt yfirlit yfir verkefnið í heild sinni er gefið í nýlegri grein: McGovern et.al. í *American Anthropologist* 2007 109 (1) 27-51

húsið, þó sá hóll sé ívið lægri. Nú er grænmetisbeð þar sem bærinn stóð og sagði frú Gerður Benediksdóttir á Skútustöðum III frá því að þar hefði komið upp aska, beinarusl og ýmislegt fleira innan um rófurnar. Uppgraftarsvæðið, þar sem grafið var sumarið 2008, er sunnan við íbúðarhús Gerðar og aftan, vestan, við gamla bæjarstæðið. Þar voru opnaðir tveir skurðir, svæði D og F auk þess sem snið, sem varð til þegar stungið var frá íbúðarhúsinu að Skútustöðum III haustið 2007 vegna vinnu við klæðningu, var hreinsað og stækkað til suðurs, svæði E1 og E2. Hvert jarðlag ver grafið fyrir sig og teiknað upp og skráð sérstaklega (sjá jarðlagaskrá í viðauka) og hver mannvistarlag var sigtað í 4mm sigti til að tryggja að öll bein og gripir væru hirt. Einnig var tekið 10 ltr sýni til blautsigtunar fyrir plöntuleifar úr hverju mannvistarlagi sem var stærra en 30 ltr og fór blautsigtunin fram á vettvangi. Auk þess voru sýni tekin úr sniðum til að greina skordýraleifar. Plöntuleifagreining stendur nú yfir sem og rannsókn á skordýraleifum en niðurstöður liggja ekki fyrir. Þær verða gefnar út í næstu framvinduskýrslu, vorið 2010. Greining á gripum er lokið og er fundaskýrsla hér að neðan (á ensku) sem og skýrsla um beinagreiningu sem nú er lokið (einnig á ensku) en ekki er búið að fullgreina fiskibein enn þá.

Auk þess sem skurðir voru opnaðir var svæðið kortlagt og dýpt og umfang öskuhaugsins áætluð með því að taka borkjarnasýni með 3mm jarðvegsbor með reglulegu millibili.

## Umfang og dýpt öskuhaugsins

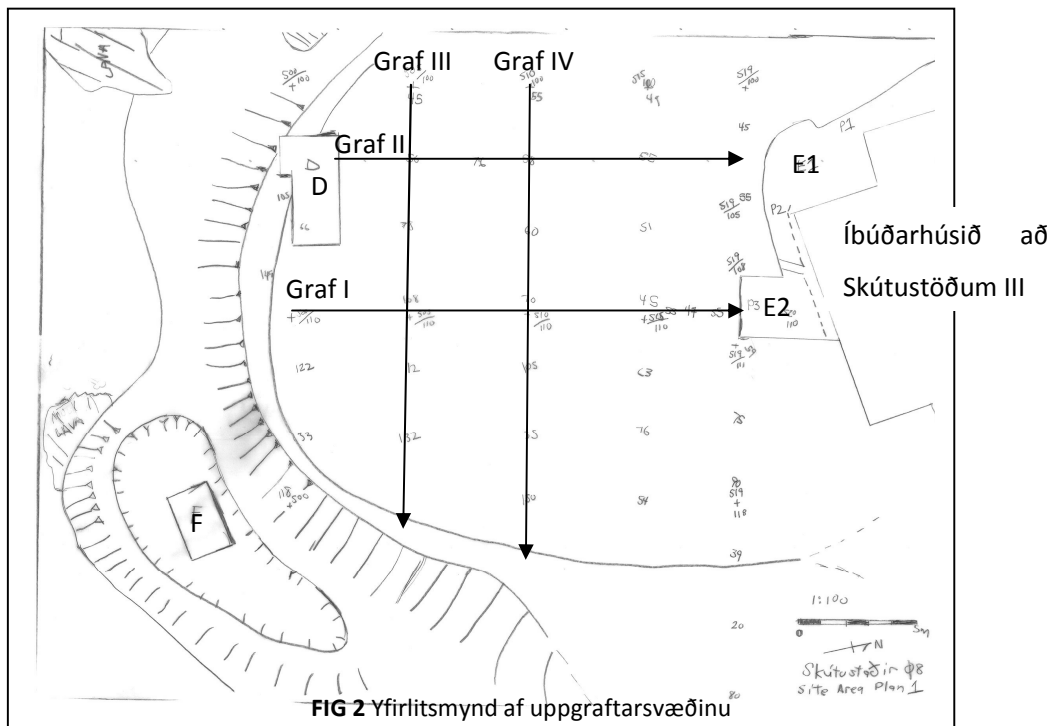

Íbúðarhúsið á Skútustöðum III stendur á flöt uppi á hól sem hallar bratt til suðurs um 20 m sunnan við húsið og til vesturs um 15 m vestan við vesturmörk þess. Mælingar sem gerðar voru sumarið 2008 sýna að náttúrulegt yfirborð, þ.e. yfirborðið undir öskulögnum hallar hraðar og brattar bæði til suðurs og vesturs og því ljóst að flötin sunnan við húsið er að miklu leyti manngerð. Stærð öskuhaugsins samsvarar stærð flatarinnar að mestu leyti og virðist vera um 15x35 m stór austur-vestur en ljóst er að öskulög eru einnig í brekkunum neðan flatarinnar, eins og skurður F leiddi berlega í ljós. Örvarnar á myndinni hér að ofan sýna stefnu þeirrar lína sem mældar voru og niðurstöður þeirra mælinga eru sýndar í gröfunum I-IV hér að neðan.

**Graf I**

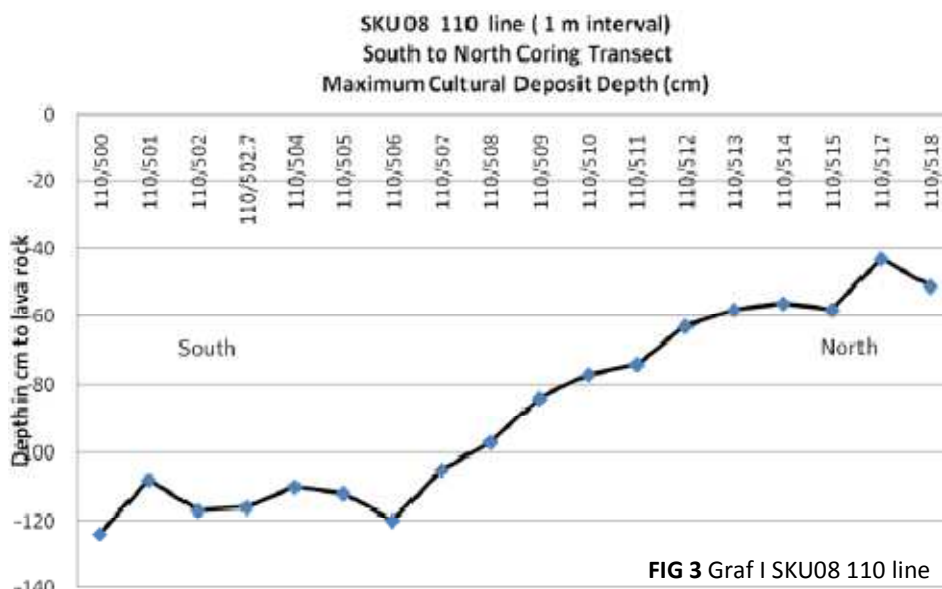

**Graf II**

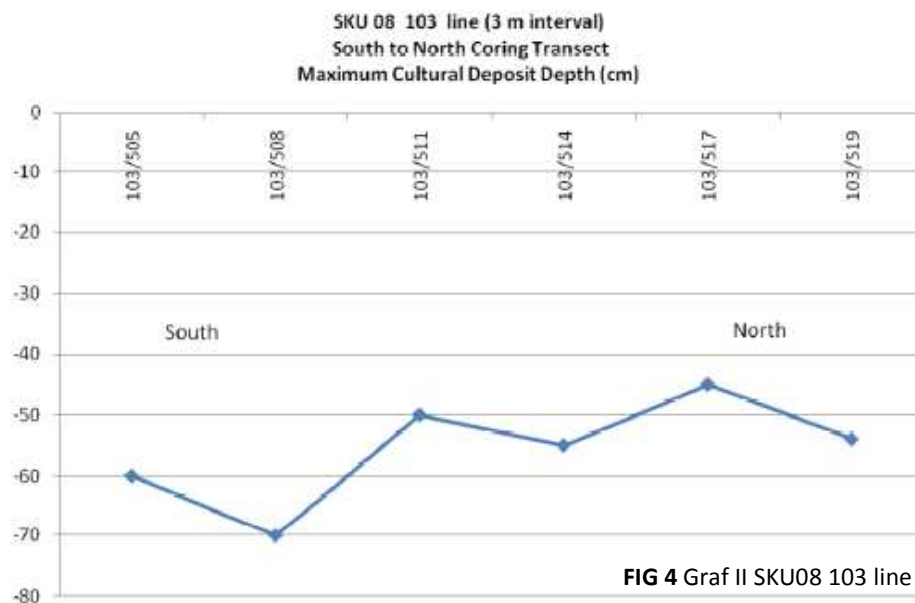

**Graf III**

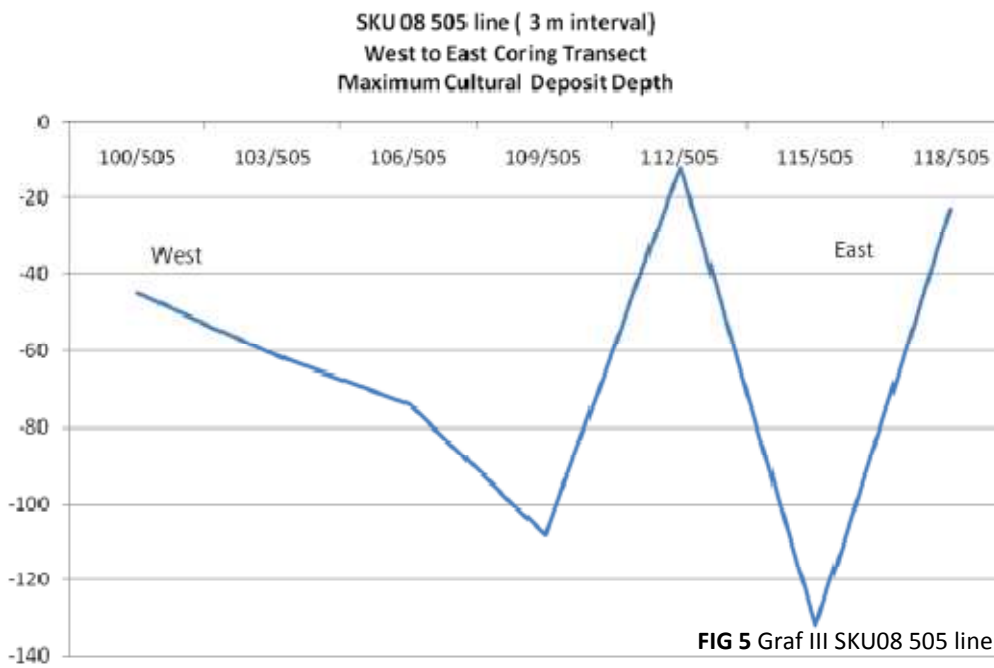

**Graf IV**

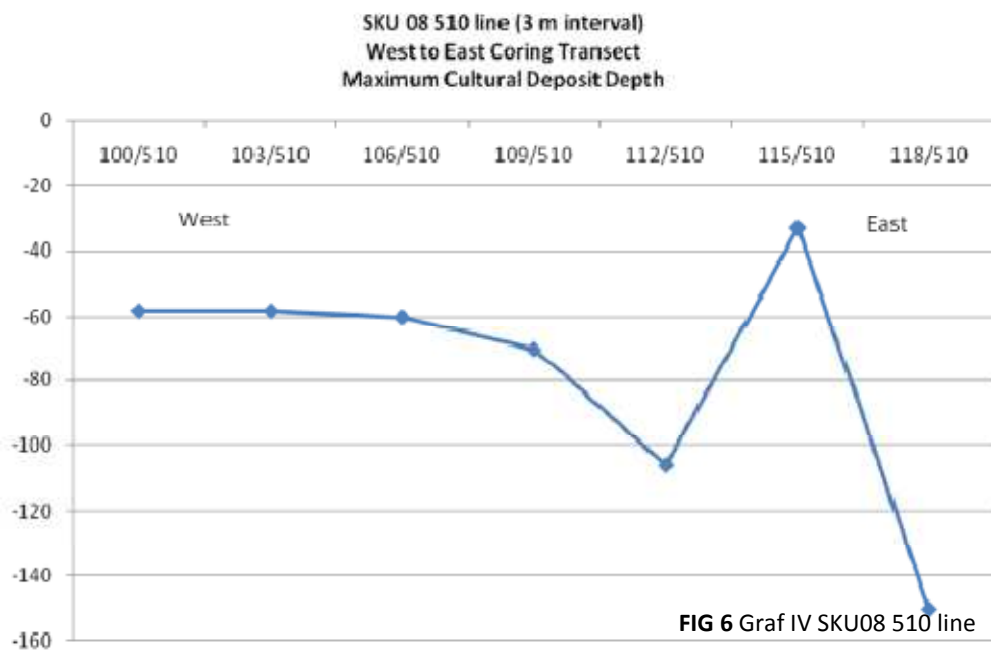

Graf I sýnir niðurstöður mælinga frá suðri til norðurs í átt að íbúðarhúsinu, á hnitalínu 110. Mælingarnar voru teknar á 1 m millibili. Landi hallar dálítið til suðurs á yfirborði en mælingarnar sýna að náttúrulegu yfirborði svæðisins hallar enn brattar til suðurs og að mannvistarlögin eru dýpst syðst um 130 cm.

Graf II sýnir niðurstöður mælinga frá suðri til norðurs sem voru teknar á hnitalínu 103, 7 m vestar en mælingarnar á grafi I. Þar er það sama uppi á teningnum þ.e. mannvistarlögin eru dýpst syðst en þau eru þó mun grynri en þau eru sjö metrum austar og mesta dýpt einungis um 70 cm. Það kemur vel heim og saman við mælingarnar sem gerðar voru frá vestri til austurs og sýndar eru á gröfum III og IV.

Graf III sýnir mælingar sem gerðar voru á hnitalínu 505, frá vestri til austurs, fast norðan við skurð D. Mesta dýpt mannvistarlaga á þessum ási er austast, um 130 cm. Athyglivert er að mannvistarlögin reyndust vera mjög grunn á punktinum 112/505 (þar sem tindur er á grafinu) og þó megi vera að þar sé um skekkju í mælingum að ræða (t.d. að borinn hafi lent á steini) þá sýnir graf IV sama topp og því líklegt að um raunverulega dýpt sé að ræða. Hins vegar kom grynningin á punkti 118/505 ekki í ljós í grafi IV og þar er líklega um skekkju að ræða.

Graf IV sýnir mælingar sem gerðar voru á hnitalínu 510, 5 m norðar en mælingarnar á grafi III. Þær gefa svipaða niðurstöðu, þ.e. mannvistarlögin dýpka til vesturs og eru dýpst um 150 cm en grynka skyndilega á punkti 115/510. Það er því hugsanlegt að það sé barmur gervigígs sem liggja í sveig frá norðri til suðurs suðaustur frá núverandi íbúðarhúsi.



## Uppgriftarskurðir

### Svæði D



FIG 7 Svæði D, ný opnað. Horft til austurs

Svæði D er í norðausturhorni lóðarinnar á Skútustöðum III, um 20 m suður frá íbúðarhúsinu. Skurðurinn er á mörkum þar sem landi hallar bratt til suðurs og var hann settur þar, þar sem bein stungust út úr rofaborði í brekkubrúninni. Skurðurinn er L laga, um 2,45x5 m stór. Grafið var frá yfirborði og niður á náttúrulega hraunklöpp (Laxárhraun yngra sem er um 2000 ára gamalt). Alls voru 24 jarðlög skráð í skurðinum, flest ruslalög en nokkur fokmoldarlög auk tveggja gjóskulaga. Gjóskulögin sem voru

greinileg í skurðinum voru V-1717 (031) sem var um 30 cm undir yfirborði og náði það yfir allan skurðinn. Lagið var úr grófri, dökkri gjósku og var mest um 2 cm þykkt. Eldra gjóskulagið í skurðinum (064) er líklega V-1477 en það fannst einungis í austurenda skurðsins, um 60 cm undir yfirborði. V-1477 gjóskulagið var allþykkt, um 3 cm, fíngert og blátt að lit. Skurðurinn var dýpstur í austurendanum, um 1,2 m en hann var mun grynri syðst eða einungis um 80 cm þar sem hraunlöppinni hallar allbratt til austurs.

Langflestir gripir frá svæði D komu úr efstu mannvistarlögunum (1 og 2) og hafa verið aldursgreindir til 19. Aldar en allnokkrir komu úr lögum fyrir neðan V-1717 og eitt klébergsbrot fannst sem hugsanlega er frá miðöldum (sjá umfjöllun um fundi).



FIG 8 Svæði D eftir að uppgreftri var lokið.

Horft til austurs

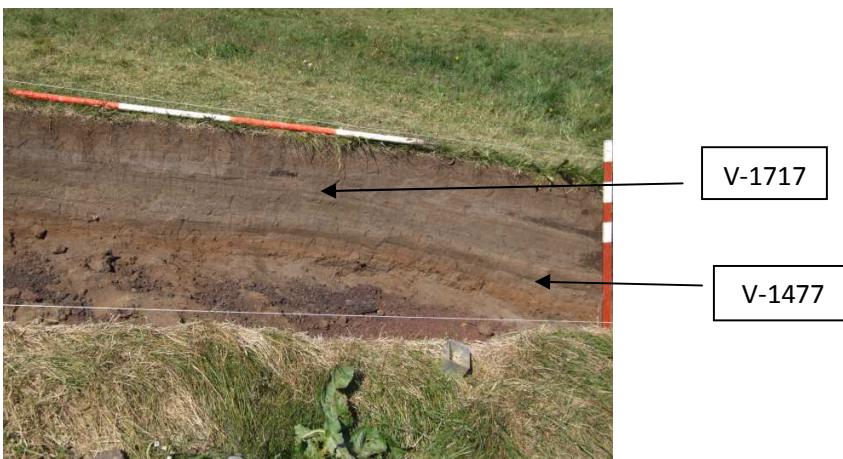

FIG 9 Snið í norðurhlíð skurðs D

## Svæði E1 og E2



**FIG 10** Svæði E1, áður en að hreinsun hófst. Horft til norðurs

Snið sem varð til þegar skurður sem tekinn vestan íbúðarhússins að Skútustöðum III, þegar það var klætt, og snýr norður-suður var nefnt svæði E1. Sniðið var hreinsað og teiknað auk þess sem bein sem stóðu út úr sniðinu var safnað. Fjöldmörg gjóskulög ásamt þykkum ruslalögum með mikið af beinum í, sáust í sniðinu og samkvæmt gjóskulagagreiningu spanna þau tímabilið allt frá landnámi og til 20. aldar. Landnámssyrpan V- 950 (026) var greinileg neðst í sniðinu á einum stað þar sem jarðvegur hafði safnast saman ofan í hraungrjótu. Afstaða elstu ruslanna og

landnámsgjóskunnar bendir til að elstu ruslalögin á svæði E1 séu frá 11.-12. öld.



**FIG 11** Snið E1, horft til vesturs

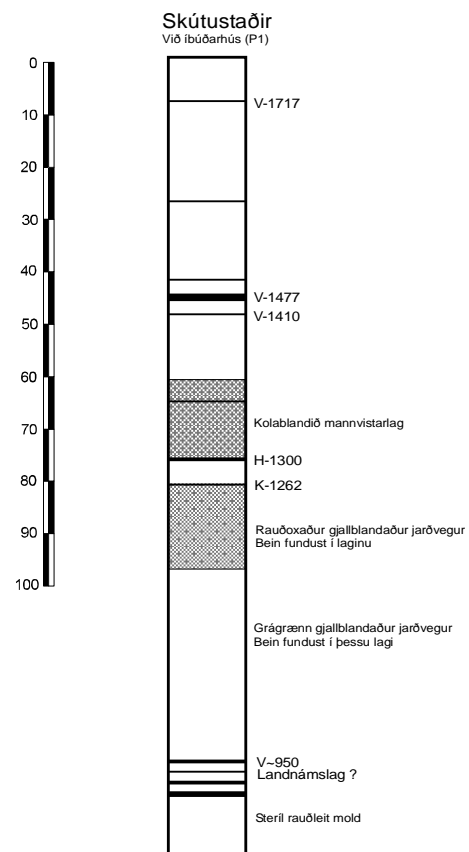

**FIG 12** Gjóskulagagreining í sniði E1  
Magnús Á. Sigurgeirsson



FIG 13 Svæði E2, horft til suðvesturs



FIG 14 Mannvistarlag 063 á svæði E2, horft til norðausturs

Sniðið í klæðningarskurðinum sem sneri austur-vestur, sunnan við íbúðarhús Skútustaða III, var nefnt svæði E2. Það snið var einnig hreinsað og teiknað. Mannvistarlög komu í ljós austast í botni klæðningarskurðisins og var því ákveðið að opna lítið svæði út frá sniði E2 til suðurs og austurs og mæla lögin og grafa upp. Mannvistarlögin voru undir þykku gjóskulagi sem líklega er V-1477 (en hugsanlega landnámslagið) og þau innihéldu mikið af beinum af geitum, svínunum, nautgripum, fé, fuglum, sjávar og ferskvatnsfiskum sem og eggjaskurn. Neðst á svæði E2, ofan á náttúrulegu hraunklöppinni var grátt öskulag (062) sem fyllti smávegis bolla í hrauninu og í því fannst perla sem hefur verið aldursgreind til víkingaaldar (sjá umfjöllun um fundi). Aðrir gripir sem eru aldursgreinanlegir frá svæði E1 og E2 eru naglar úr efstu mannvistarlögunum og eru þeir frá 19. öld. Eftirtektarvert er að engin leirkerabrot né glerbrot fundust á þessu svæði.

Fimm sýni voru send til C14 greiningar frá svæði E1 og E2.

SUREC 20218 sýni úr nautgripabeini í lagi 063 sama lagi og perlan frá víkingaöld kom úr (sjá kafla um fundi) gaf niðurstöðuna 690-890 AD. Sýni SUREC 20019 úr kindabeini úr lagi 049 gaf niðurstöðuna 890-1040 AD, sýni SUREC 20220 úr kindabein úr lagi 019 gaf niðurstöðuna 1205-1285 og sýni SUREC 20225 og SUREC 20226 voru tekin úr kinda eða geita beinum úr lagi 006, 20225 var takið neðarlega úr laginu og gaf niðurstöðuna 1280-1400 AD og 20226 var tekið ofarlega úr laginu og gaf niðurstöðuna 1320-1450 AD. Nánari staðsetningu lagana má sjá í viðauka í sniðteikningum og í harris matrixi fyrir svæði E1 og E2.

### Svæði F



FIG 15 Svæði F, ný opnað. Horft til vesturs



FIG 16 Veggur 080 í skurði F, horft til norðurs

Svæði F er í brekkunni sunnan við Skútustaði III, um 25 m SSA við íbúðarhúsið. Þar var opnaður 2x3 m stór skurður sem snýr

austur-vestur. Alls voru 17 jarðlög skráð og grafin upp í skurðinum. Flest voru þau ruslalög líkt og í skurði D en einnig var nokkuð um lög sem voru rík í torfi og í síðustu vikunni áður en uppgreftri var hætt kom í ljós veggur nyrst í skurðinum. Það er því ljóst að þar hefur verið bygging sem hefur fallið úr notkun og rusli og ösku verið helld yfir hana. Hún hefur hugsanlega verið lítil rétt eða kvíar frá bænum. Engin gjóskulög voru greinileg í skurði F en þó er hugsanlegt að slitur af V-1717 séu í sniði en gjóskulagið var ekki greint í plani á meðan á uppgreftri stóð. Gripir frá svæði F eru líkt og frá svæði D aðallega frá 19. öld.

## Finds

*Preliminary assessment by Guðrún Alda Gísladóttir with contributions from Elín Ósk Hreiðarsdóttir, Sigríð Juel Hansen and Gavin Lucas.*



**FIG 17** Artefact <67>. Clothing fastener



**FIG 18** Artefact <28>. Copper alloy pin

The finds database from season 2008 from Skútustaðir now contains 358 finds registered under 127 finds numbers. Few finds were retrieved from bone bags during assessment and have not been registered in the database (mainly from area E1&E2). In the database ca. 25 g of slag is included and registered but not given count value. One find number, 042 was discarded and one find, 040 was not present during assessment in April 2009.

The preservation conditions at the site are poor; iron objects that were retrieved are in poor condition and organic artefacts of textile, leather and wood are few despite a large amount of animal bones in excellent conditions having been retrieved. All finds were processed at Fornleifastofnun Íslands and registered in the excavation database. Conservation work will be concluded by the National Museum of Iceland.

Three trenches were excavated during the 2008 season; D, E1&2, and F. Rich midden deposits were recorded in all trenches. The division between different materials in the whole assemblage is shown in table 1 and Fig 19 below.

**TABLE 1.** Number and percentage of finds according to material

Material	Sum	%	Find categories
Bone	3	1	Worked
Ceramic	137	38	See Gavin Lucas report
Composite	2	1	Pin, knife
Cu-Alloy	20	6	Mount, clench bolt, sheeting, fragment, button, clothing fastener, fittings, vessel
Glass	66	18	See Gavin Lucas report, bead
Iron	109	31	Hooks, nails, clench bolts, knife, rove, pin, loop, ring
Lead-Alloy	4	1	Pin, sheet, ring
Stone	15	4	Hammer, whetstone, manuport
Stone?	1	0	
Textile	1	0	Indet
<b>Total</b>	<b>358</b>	<b>100</b>	

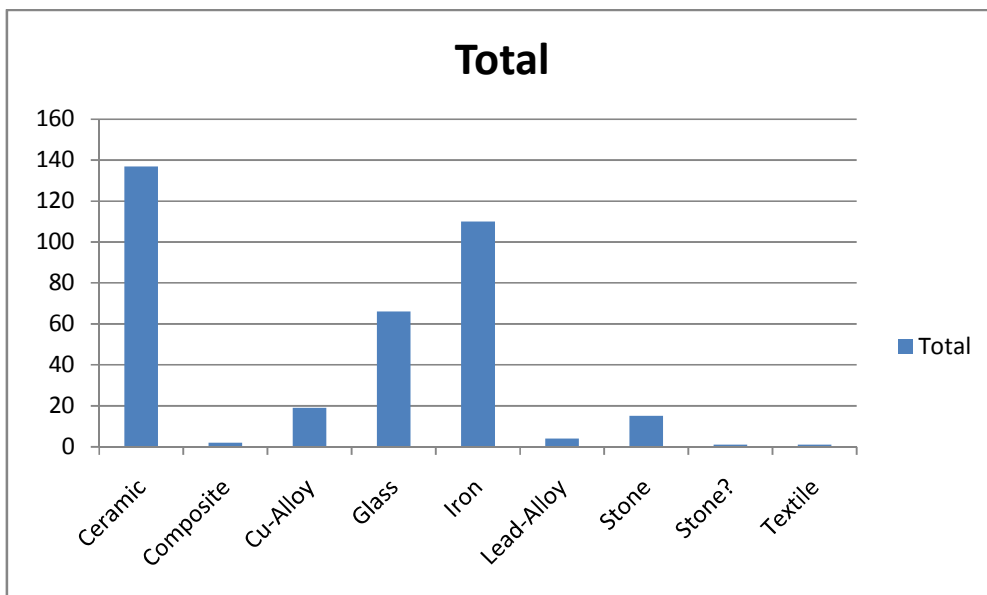

**FIG 19** Number of finds according to material

## Discussion

Preliminary assessment on the finds from Skútustaðir suggests that the finds assemblage in areas D and F are fairly similar and date chiefly to 19<sup>th</sup> century - though few earlier and later artefacts are present (18<sup>th</sup> and 20<sup>th</sup> century). Of interest are e.g. 'personal items' and decorative artefacts that are present such as clothing fasteners, clench bolts from a chest (?), mounts and buttons. Also present are small hooks, possibly from a spindle and a nice small pin. Area E1&E2 reveal earlier remains than excavated in D and F. i.e. the a Viking age bead. Other finds of interest from that area, are possible copper cooking vessel and a loop that could be fragment of vessel suspension fitting.

### Area D



FIG 20 Artefact <29>. Stonehammer

From this area 169 artefacts were retrieved and registered under 50 finds units. Registered contexts are 11: [1, 2, 32, 46, 52, 55, 57, 60, 61 and 71]. The finds richest contexts by far are [1 and 2] ca. 30-50 artefacts but contexts [32, 46, 52, 55 and 57] follow with ca. 13-20 finds. Diverse find types were retrieved from area D, i.e. glass and pottery, nails, button, needle, fragment of copper alloy vessel (?), stone hammer, fittings and clothing fasteners. In context [61] the only find was a steatite chip which could suggest medieval or even still earlier period – if not re-deposited. Datable finds (nails, ceramic and glass) from that area suggest chiefly 19<sup>th</sup> century.

### Area F

From this area 165 artefacts were retrieved, registered under 58 finds units. Registered contexts are 13: [33, 35, 36, 45, 47, 50, 62, 68, 69, 73, 74, 75 and 77]. The finds richest contexts by far are [33 and 36] with 43 and 44 finds but others all below 15. Similar finds assemblage was retrieved from this area as in D and finds from that area suggest chiefly 19<sup>th</sup> century.

### Area E1&E2

From this area 24 finds were retrieved, registered under 18 finds units. Registered contexts are 6 [7, 13, 19, 59, 60 and 63]. The find assemblage in this area is quite different from D and F, for example no ceramics or glass vessels were found in this area. Datable finds are present in contexts [7 and 13], nails that date to 19<sup>th</sup> century and in context [63] one glass bead can be dated to Viking age.

## *Specific artefacts and ceramics*

### **Bead by Elín Ósk Hreiðarsdóttir**

#### **Artefact <075> context 063**

**Material:** Glass.

**Condition:** Over 90% of the bead is preserved and it is in fair condition although part of the top layer has begun to flake off.

**Shape:** Rounded, segmented.

**Size:** Length 1,13 cm, diam. 0,53cm, diam. of hole: <0,1 cm.

**Method of manufacture:** Blown glass.

**Colour:** Gold.

**Found in context:** Area E2 [063].



**FIG 21** Artefact <75>. Viking age bead

Bead SKU 08-075 is a segmented, double bead. It is a blown bead of golden colour and is of type E130. The bead body itself is made out of colourless glass. One end of the bead is cut and the other very slightly raised. The glass is in fairly good condition although it is very mat and some of the top glass layer has eroded. Golden beads like this could be manufactured in many ways but it was most common way to achieve the golden colour was by applying a golden foil on a top of a body of a colourless glass. To seal the foil a thin layer of colourless glass was often added on top. First look indicates that this bead was only made of two layers, a colourless body and a layer of thin, golden coloured glass on top. When observed in a microscope very fine traces of what could be the golden foil could be seen in one location.

Callmer groups together golden, blown beads of this type whether they are simple or segmented. About 57 beads of type E130 had been found in Iceland until the end of 2004 and there of (but only 15 are segmented). About half of the beads of this type found in Iceland come from a single find, the burial at Vestdalsvatn but a small quantity also comes from other areas in the north east and Árnessýsla. Beads of this type had, until 2005, only been found once in an excavation of a settlement (from Suðurgata in Reykjavík *Suðurg. nr. 208*), all the others are from heathen burials.

Callmer does not give a chronological frame for this type of beads. They are not considered to have been made in Scandinavia but were imported, probably from the Eastern Mediterranean.

## **Whetstones by Sigrid C. J. Hansen**

### **Area F:**

*Artefact < 006>, Context 033:*

A whetstone fragment of the light grey Eidsborg schist type of Norwegian origin. Preserved as an end piece, estimated to be of a medium to large whetstone with an irregular rectangular square section and irregular but rounded shape of the end. Two, perhaps three grinding surfaces of which one shows sign of several vague grinding grooves. The edges are rounded due to use of the stone and the end piece show signs of cutting marks but it is unclear whether this is due to the initial shaping of the end or grinding marks.

Dimensions: In reg. sheet!

*Artefact < 082>, Context 077:*

A whetstone of the light grey Eidsborg schist type of Norwegian origin. Preserved as a whole but slightly chipped small pendant whetstone an irregular rectangular cross section. All three grinding surfaces preserved of which two shows vague grinding grooves. The edges are all very rounded due to use. The end piece has two parallel grooves around top and two grooves cut on the longitude of the end piece on two opposite sides to facilitate a strap to be wrapped around the stone for suspension. This type of suspension is not commonly found but is known from the excavation Hrísrú in Mosfellsdalur<sup>2</sup> and the Viking age trading site of Haithabu in Germany<sup>3</sup>.

Dimensions: In reg. sheet!

### **Area D:**

*Artefact < 058>, Context 057*

A whetstone fragment of the light grey Eidsborg schist type of Norwegian origin. Preserved as a middle piece, estimated to be of a medium sized whetstone with almost oval square section but with two parallel sides. The two grinding surfaces are well preserved but show no sign of grinding grooves.

Dimensions: In reg. sheet!

---

<sup>2</sup> Sigrid C. J. Hansen 2009, Whetstones from Viking Age Iceland (in process)

<sup>3</sup> Resi, Heid Gjöstein 1990, *Die Wetz- und Schleifsteine aus Haithabu. Bereich über die ausgrabungenn in Haithabu 28*, See pages 78-81, Plates 11-13.



## **Ceramics and Glass by Gavin Lucas**

The collections of ceramics and glass was small and mostly in poor condition making specific identifications difficult. As a whole however, the material spans the 17th to early 20th century and since it derives from multiple contexts, the stratigraphic sequence should be able to work well with the material to provide approximate dates for each context.

### *Ceramics*

A total of 83 sherds of pottery was recovered, comprising a mixture mostly of glazed red earthenwares and whitewares, but mostly not from the same contexts. The glazed red earthenwares are mostly small fragments, and most have a clear lead glaze, but a few sherds also occurred with green glaze, but such vessels often had mixed glazes. The identifiable forms all appear to be cooking pots and include one foot of a pipkin. On the whole, these forms occur on their own and probably date from the 17th to early 19th century, but in two cases tiny fragments of whiteware also occurred ([050] and [036]), which if not intrusive, indicate a post-1800 date. From [047] came one fragment of brown salt-glazed stoneware and from [069] came more fragments of stoneware as well as some patchy glazed red earthenwares as well as one whiteware plate fragment. The whitewares chiefly came from three layers: [001], [002] and [033] and include fragments from a painted 'peasant ware' bowl as well as a fragment from a banded slipware and others with tissue-prints. They all suggest a date of the latter half of the 19th century. One fragment of possible Chinese porcelain came from [002] and another of edge-banded European porcelain from [033]. Also from [033] came 3 sherds of an internally white-slipped orange earthenware bowl and part of a salt-glazed drain-pipe. The latter points to an early 20th century date.

### *Glass*

A total of 45 fragments of glass were recovered, about half being registered as window glass and half as vessel glass, though some of the window glass may be from square bottles/flasks. Most of the glass broadly dates to the 18th-early 20th century and is green coloured, with some clear glass as well as one fragment of blue and another of amber from [033]. The sherds were small and mostly undiagnostic, but one tall-necked flared rim of a small bottle/flask came from [002] along with a fragment of a square flask/bottle. Also from layer [036] came an interesting fragment of a neck or foot of a fine table vessel with applied thread which is probably no later than 18th century and possibly earlier (i.e. 17th century). From [033] came some colourless fragments may be from a kerosene lamp chimney. A few contexts

([001], [002], [033]) also produced clear, probably machine-rolled window glass which dates to the 20th century.

#### *Tobacco clay pipe*

12 fragments of tobacco clay pipes were identified, mostly stems, unburnished and with no markings. A small bowl fragment came from [036], but a complete one – very badly burnt – occurs in [045] and dates to the 17th century. The heel is missing and no other markings are visible.

## **A Preliminary Report of the 2008 Midden Excavation at Skutustadir, N Iceland**

Megan T. Hicks (1)

Thomas H. McGovern (2)

Ramona Harrison (3)

CUNY Doctoral Program in Anthropology (1)

CUNY Hunter College Zooarchaeological Laboratory (2)

CUNY Doctoral Program in Anthropology (3)

April 23, 2009

Contact: nabo@voicenet.com

A product of the North Atlantic Biocultural Organisation (NABO) Research Cooperative, the International Polar Year program *Human Ecodynamics* in the North Atlantic.

**Abstract:** In 2007, midden deposits associated with the 9<sup>th</sup>-19<sup>th</sup> c. archaeological site of Skutustadir in the Myvatn Lake District in N. Iceland were located. The remains were first noted by Arni Einarsson of the Myvatn Science station and later, more extensively surveyed by CUNY archaeologists. In 2008, a joint CUNY/FSI team excavated three trenches and located midden deposits which are the subject of this preliminary zooarchaeological report. The trenches exposed archaeological material which dates from the settlement age (871-930 CE) through the early modern period (17<sup>th</sup> - 19<sup>th</sup> c.). The data demonstrate

that site residents managed cattle herds for dairy and kept sheep likely for wool. Very scarce evidence suggests the presence of pigs and goats; however, more data needs to be collected on these species. Evidence of domestic fowl (chicken (*Gallus gallus*)), was found, distinguishing Skutustadir from other Myvatn area farms investigated to date. Local waterfowl were found as well as grouse, a local terrestrial bird, and one example of a Sea Eagle. Fish bones recovered in the 2008 field season have not yet been analyzed, however, preliminary evidence suggests that both marine and freshwater species are present. In a preliminary check, cranial bones of marine fish were observed, indicating that at least some of the marine fish transported to the inland site at Skutustadir, were fresh (not the common headless, dried fish product (Perdikaris & McGovern 2006)). Seal bones are found at a low frequency, but consistently throughout the site. These fresh marine resources, seen in some contexts (seal and fish), set Skutustadir apart from other sites in Myvatn which obtained mostly dried fish, prepared for trade, from Iceland's coast.

### *Introduction*

The discovery of Skutustadir's midden containing evidence of long term occupation from the 9<sup>th</sup>-19<sup>th</sup> c. is exciting for researchers studying the occupation of the Myvatn Area. Although the archaeological record there is rich and well studied (See McGovern et al 2007), there has been a relative dearth of evidence recovered that would indicate the nature of resource use during the late medieval and early modern periods.

### *Excavation and Recovery*

The excavation in 2008 focused on three areas: E1 & 2, D and F. Dating of the material was possible in the field by the presence of volcanic tephra layers dating to specific eruptions. Laboratory analysis of the tephra layers (by Jennifer Brown of Stirling University, UK) followed the field season and radiocarbon dating of bone recovered from Skutustadir was carried out at the Scottish Universities Environmental Research Centre (SUERC). Artifacts were also used to corroborate chronological information.

Trench E1 & 2 was located next to the site's modern habitation. Area E contained the following bone bearing contexts: 019, 006, 059, 063, 060. The results indicate that bone material recovered from contexts in Area E1 & 2 spanned time periods from the 9<sup>th</sup> century to the 13<sup>th</sup> and 14<sup>th</sup> centuries. The

lowest layers of area E1 & 2 yielded evidence that the site had been occupied since the first settlement of Iceland in the 9<sup>th</sup> century.

Area D was excavated on the southern slope of the farm mound and material here was defined by the presence of the V1477 tephra and the H 1717 tephra with anthropogenic deposits both above and below each, thus dating it to the Late Medieval and Early Modern periods in Iceland. Area D contained bone-bearing contexts: 002, 055, 062, 061, 057, 056, 052, 046, 044, 032, and 007. Preservation in area D was excellent, and as a result, excavators were able to recover delicate specimens such as bird egg shell and fish ear otoliths (inner ear bones).

Area F was excavated south- east and downslope of Area D and the small trench yielded material dating to the 18<sup>th</sup> and 19<sup>th</sup> c, the Early Modern period in Iceland. Area F contains the contexts: 054, 047, 077, 076, 075, 074, 073, 069, 068, 051, 054, 036, 050, 045, 035, 034, and 033. In contrast to area D, the bone recovered from area F frequently was poorly preserved, with specimens showing exfoliation (flaking off of outer layers), eroded bone surfaces, and specimens were generally more fragile.

In order to simplify information in this preliminary report, some data will be presented in groups by age as follows. Data pertaining to transitional period will be noted as such.

**TABLE 2. Ages and Bone- bearing Contexts at Skutustadir 2008**

Age	Dates	Contexts
The Viking age ( <i>landnam</i> )	871-930 CE (9 <sup>th</sup> -10 <sup>th</sup> c.)	E1 & 2 063
The Medieval Period	1000-1600 CE (11 <sup>th</sup> -17 <sup>th</sup> c.)	E1 & 2 059, 006, 019, 060 D
Late Medieval to Early Modern	between 1477 and 1717 tephra	D 061, 062, 057, 056, 055, 046, 044
Early Modern Period	1600-1800 CE (17 <sup>th</sup> -19 <sup>th</sup> c.)	D 002, 007 F 033, 034, 035, 036 045, 047 050, 051, 054, 068, 069, 073, 074, 075, 076, 077, 096

The following measures were taken in accordance with NABO and FSI recommendations to ensure excellent recovery in the field: All midden material bearing bone was dry-sieved through 4mm

mesh. Regular checking of the resulting back-dirt suggests that few elements were missed by the sieving methods. All articulated elements were placed in one bag in the field and subsequently recorded as one specimen to reduce interdependence. Thorough recovery of the faunal material was further ensured through the careful excavation approach by several team members with previous zooarchaeological training.

### *Laboratory Methods*

As of April 2009, laboratory analysis of the bird and mammal bones from Skutusatdir is complete. Analysis was carried out at the Hunter College Zooarchaeological Laboratory and made use of the extensive reference collections there. Analysis of the fish bones recovered in 2008 will be carried out at the Brooklyn College and the Hunter College Zooarchaeological Laboratories. All elements were identified as far as taxonomically possible (a selected element approach was not employed) but most mammal ribs, long bone shaft fragments and vertebral fragments were assigned to “Large Terrestrial Mammal” (cattle or horse sized) , “Medium Terrestrial Mammal” (sheep, goat, pig or large dog sized), and “Small Terrestrial Mammal” (small dog-fox sized). Only elements positively identified as *Ovis aries* and *Capra hircus* were assigned to the separate sheep and goat categories respectively while all other sheep/goat element were assigned to the “caprine” category potentially including both sheep and goats. Digital records of all data collected were made following the 8<sup>th</sup> edition of the NABONE recording package (a Microsoft Access database supplemented with specialized Microsoft Excel spreadsheets). This report, other reports and data are available from [nabo@voicenet.com](mailto:nabo@voicenet.com) and the NABO website: [www.nabohome.org](http://www.nabohome.org).

Curation followed the NABONE protocols followed for other archaeofauna from Iceland, Faroes, Greenland, and northern Norway (NABONE, 2004, see [www.nabohome.org](http://www.nabohome.org) for downloadable version 8). Following widespread North Atlantic tradition, bone fragment quantification makes use of the Number of Identified Specimens (NISP) method (Grayson 1984). Mammal measurements (with a Mituyo Digimatic caliper) followed the approach outlined by von den Driesch (1976), and sheep/goat distinctions follow Boessneck, (1969) and Halstead and Mainland (2005). Tooth-wear stage studies follow Grant (1982) and long-bone fusion stage calibrations follow Reitz and Wing (1999).

## *Taphonomy*

The physical condition of bone transforms multiple times during its journey from a living animal to a laboratory specimen through decay, fragmentation and other processes. This may inhibit our ability to derive information from an archaeofaunal assemblage and may impede its comparison of multiple assemblages (Lyman 1994). It is because of these factors of change that zooarchaeological evidence is indirect evidence and an assessment of taphonomic (post death) factors is important in any analysis.

Most bone found in middens is significantly fragmented having undergone processes such as butchery by humans, natural decay, trampling and gnawing by carnivores. Burnt bone is especially prone to fragmentation. Specimens analyzed were classed into size categories to determine the extent of fragmentation of the assemblage. A total sieving regime, as detailed above, often results in a collection with a high proportion of specimens in the smaller size classes.

**TABLE 3. NISP in various size categories**

Unit	<1 cm	1-2 cm	2-5 cm	5-10 cm	>11cm
D	818	2074	1511	248	100
E2	430	671	607	158	41
F	661	1098	722	147	74

When found in Icelandic domestic contexts, burnt bone is believed to be the result of dining and food preparation activities resulting in bone being casually tossed into a domestic hearth. Debris from hearth cleaning is then transferred to the midden as with other household refuse. The observed conditions of burnt bone are categorized here into three types: un-burnt bone, black burnt bone (bone in which the collagen becomes carbonized creating a black appearance), scorched bone (bone which has had brief contact with fire and heat, creating a black mottle on an otherwise un-burnt specimen), and white burnt bone (bone which has had all of the collagen burnt away- a white, chalky, calcined appearance). Bone can become white and calcined quickly, so black and scorched bone is likely the product of only brief and non- intense contact with fire. Calcined bone is often preserved (along with teeth) even when preservation conditions are at their worst. Poor condition for bone preservation often results in contexts containing only calcined bone and teeth. Below, burnt bone at Skutustadir is charted.

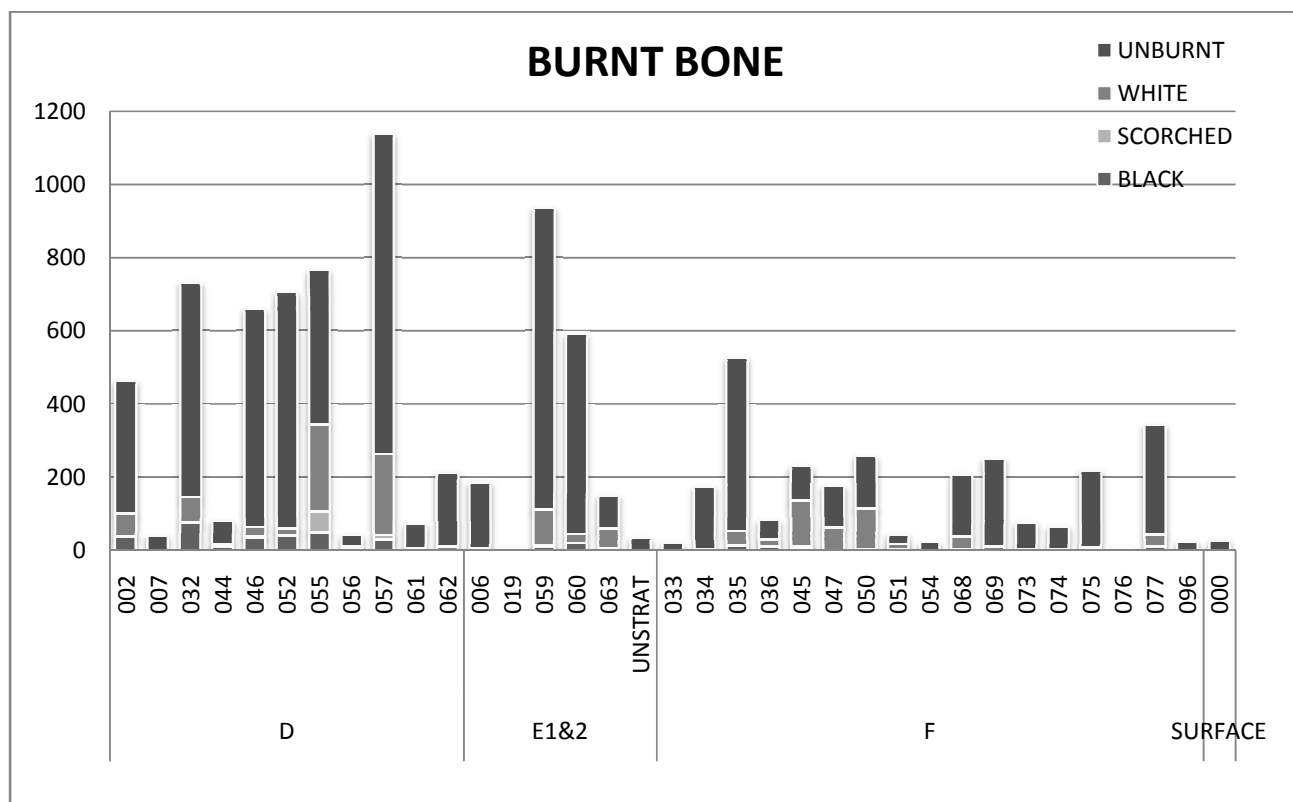

FIG 22. Burnt bone frequency throughout Skutustadir

Un-burnt bone is most frequent, followed by white burnt bone. Black burnt bone and scorched bone are uncommon throughout the majority of contexts. Scorched bone was unusually common in context 055 in Area D. This may have been the result of a unique cooking or disposal practice not seen in other contexts.

Assemblages often undergo extensive gnawing by scavengers, carnivores, domestic pets such as dogs, and pests such as rodents. Only one bone specimen recovered showed evidence of gnawing by rodents, while several showed evidence of chewing by dogs. Overall, the assemblage did not appear to be overwhelmingly disturbed by such processes.

TABLE 4. Gnawing by dogs (*Canis familiaris*)

Unit	#Gnaw NISP	Total #NISP	%Gnaw
D	141	4909	2.82%
E2	25	1908	<1%
F	23	2725	<1%

Intentional fragmentation of bone by humans is a significant source of taphonomic alteration. The full range of butchery signatures was observed in the assemblage from Skutustadir. This included evidence of chopped bone (bone divided with a heavy impact using a sharp instrument), split bone (long bone split to expose the marrow cavity), and knifed bone (bone marked by use of a cutting tool). Culturally specific butchery signatures were noted including biperforation of metapodials which involves the creation of two holes on either end of the metapodial, allowing marrow to be extracted without otherwise fragmenting the bone. (Please refer to the NABONE manual for an extensive review of classification of butchery signatures.)

The past inhabitants of Skutustadir also drew on animal bone as a useful raw material and may have worked bone and horn on site. Several diverse examples of worked bone were present in the assemblage including a drilled cow astragalus, a sheep and cow metapodial shaped and oriented with the former inside the later, as well as an item made of smoothed cetacean bone (whale or porpoise bone). Evidence of horn working was recovered in the form of both horn core fragments (of caprines and cows) and skull fragments showing evidence of intentional horn removal taking place after the animal's death.

### *Subsistence*

Previous studies have suggested that caprines and cattle traditionally comprised Icelandic farms. The study of the age at death of these animals as well as the ratio of caprines to cattle has lent further complexity to the subject, allowing for a more detailed discussion of economic motives (McGovern et al 2007). In Iceland's past, both caprines and cattle were consumed for meat while caprines were also kept for wool and cattle for extensive dairying activities (for a complete discussion on the use of zooarchaeological evidence in determining herding strategies see Payne (1973) and Halstead (1998). For more information on the results from other Icelandic excavations, please see the reports available at [www.nabohome.org](http://www.nabohome.org)). Both wool and dairy were of central economic importance and could be used as currency, i.e. in payment of tithes (Karlsson 2000: pp 50 & 244).

Where wool is central to the economy of a particular site, caprines are mostly seen to be slaughtered during adulthood, maximizing their wool production per individual. Previous zooarchaeological studies have hypothesized that in the late Medieval Period, an increase in trade of monetized wool products parallels the increase in numbers of caprines vs cattle in Icelandic domestic



stocks (McGovern 2007). Preliminarily, it appears that there may be an increase over time in the caprine to cattle ratio at Skutustadir. The later contexts showed a high caprine to cattle ratio however larger sample numbers recovered in the upcoming 2009 season will be beneficial in confirming or negating this preliminary view.

Where cattle-based dairying is important, a large proportion of neonatal cattle bone is found in an archaeological assemblage. By keeping cows in calf-bearing cycles, they continuously produce milk and calves for human consumption (Halstead 1998). On the other hand, in a cattle economy based solely on meat production, cattle are slaughtered when they reach prime age and mature body size. Based on the archaeofauna collected in the 2008 field season, there is sufficient evidence that past residents of Skutustadir were practicing a dairy economy. In some contexts, nearly half of the cattle bones recovered are those of newborn calves (see chart below).

In contrast to the high number of neonatal cattle per adult cattle, only 18 total NISP of neonatal caprines were documented from the entire assemblage, across all contexts. This may demonstrate separate herding strategies as well as separate economic uses for cattle and caprines.

Further description of the herding strategies employed by the Skutustadir residents will be reserved for the full zooarchaeological laboratory report which will follow this report and will include size and age reconstructions based on bone metrics as well as analyses of mandibular tooth eruption and wear (following von den Dreisch 1976 and Grant 1982).

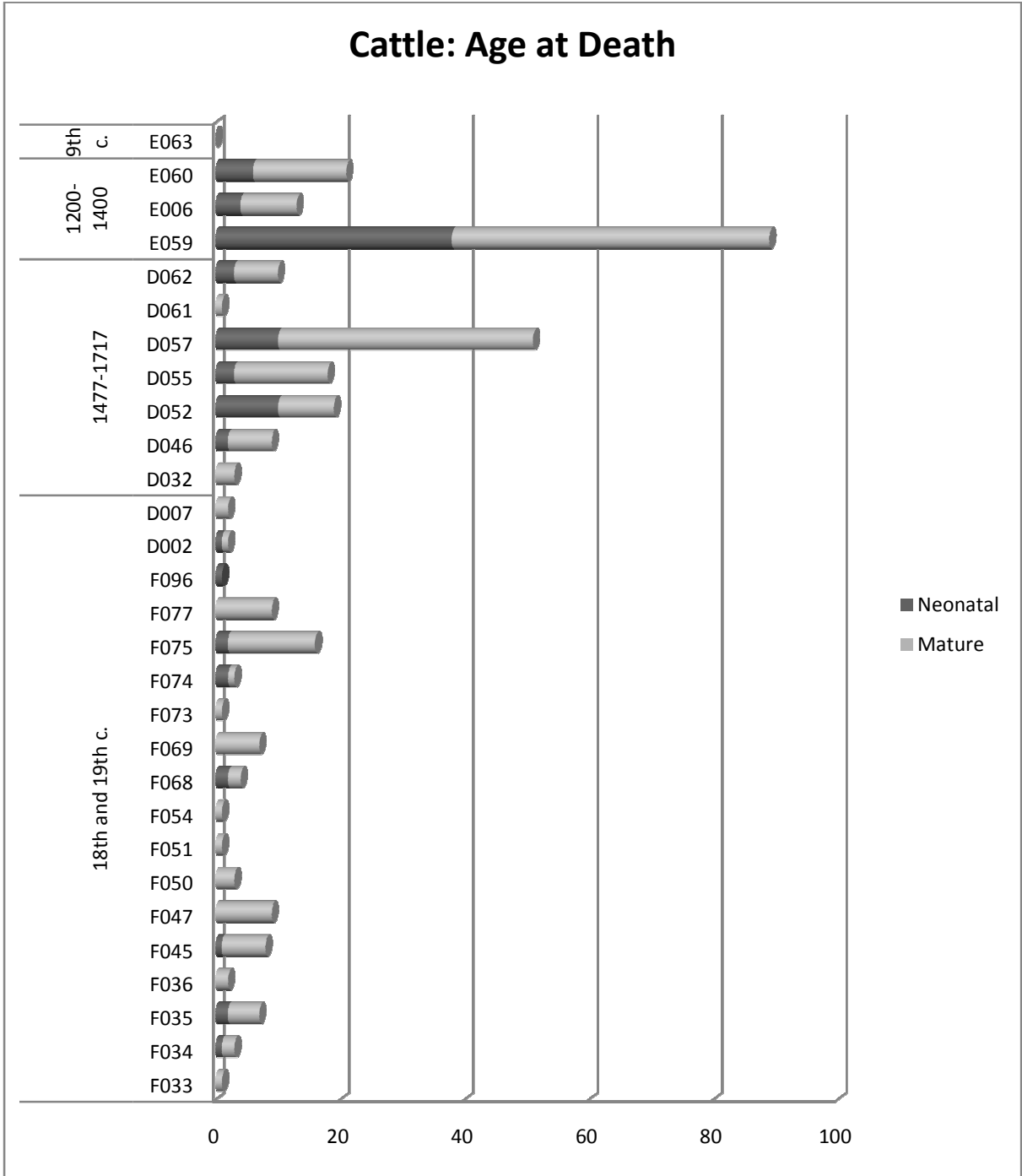
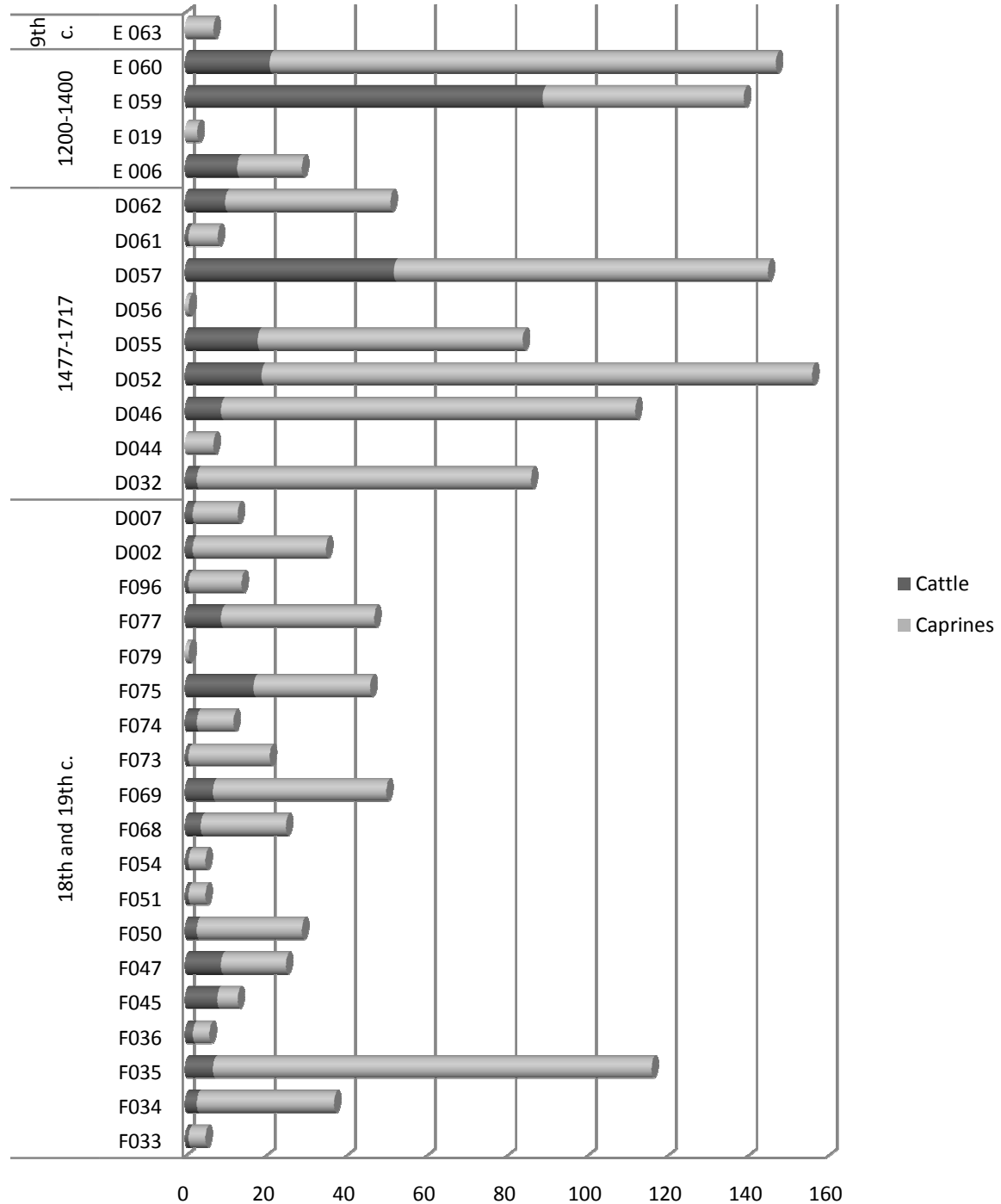

FIG 23 Cattle: Age at Death

## Cattle vs. Caprines



**FIG 24** Cattle vs. Caprines



**FIG 15. Extreme dental wear and pathology has adversely affected some caprines at Skutustadir**

Skutustadir today supports herds of cattle due to its proximity to ideal cattle grazing land- Myvatn's framengjar (wet meadows). It is possible that past residents took advantage of this nearby resource to keep ample herds of cattle as well. An isotopic study of N15 present in cow and caprine bone from Skutustadir is planned to explore the hypothesis of separate caprine and cattle grazing land. A second important component of the planned study will examine mandibular tooth wear which may indicate whether caprines regularly grazed in pasture with higher content of grit (following Grant 1982) when compared to cattle tooth wear. For a quantifiable sample, it will be necessary to recover more mandibles of both species in the 2009 excavation season at Skutustadir.

Horse (*Equus caballus*) remains were represented by two specimens— one, a third phalanx (hoof), and the other a small metacarpal. It is believed that horses were not eaten approximately after the Christianization of Iceland around 1000 CE as Icelanders increasingly adopted alternate customs alongside their new religion (Karlsson 2000, p 46).

Two specimens of pig (*Sus scrofa*) remains were found in the midden at Skutustadir: a canine tooth and an ulna. The ulna was found in an unstratified context in area E, and the canine tooth, in Area F, in an early modern context. The quantity of remains may not be sufficient to confirm that pigs were kept by past site residents. The recovery of more zooarchaeological material in the 2009 excavation

season will add to our knowledge of the nature of pig keeping (or its absence) at Skutustadir and Lake Myvatn in general.

Bird species found throughout the site include Mallards (*Anas platyrhynchos*), Red Breasted Merganser (*Mergus serrator*), Swans (*Cygnus sp.*) and Swan-sized specimens, Slavonian Grebe (*Auritus podiceps*), Long-tailed ducks (*Clangula hyemalis*) and tufted ducks, all ground-nesting natives of the lake Myvatn. Another present avian species was ptarmigan (*Lagopus mutus*), a local terrestrial species. Marine avian species were not found in the assemblage. Bird egg shell was found but will require analysis at the micro-level in order to determine the species. Bird egg shell found at other lake Myvatn sites has pointed to a long term tradition of sustainable harvest of bird eggs, beginning in the 9<sup>th</sup> centuries and still carried out today (McGovern et al 2007). The presence of a variety of local birds in the midden suggests that the harvesting of local birds as food was not focused on a single local species.

Evidence of chickens at Skutustadir consists of only two specimens in the entire assemblage. In Area E2 Context 059, a femur and a tibiotarsus were found (both are bones of the leg). These are the only data on chickens (*Gallus gallus*) available from the archaeo-fauna recovered from the Lake Myvatn Area (McGovern, personal communication). Context 059 appears to date to the late 13<sup>th</sup> century, a late Medieval context.



**FIG 26 Tibiotarsus of domestic chicken (*Gallus gallus*)**

A total of 53 seal (Phocid species) elements were found in the assemblage from Skutustadir. They were found throughout several contexts and time periods. All elements are represented throughout the assemblage including skull fragments, vertebral fragments, long bones, phalanges and teeth. Two specimens were identifiable to the species level as harp seals (*Pagophilus groenlandicus*)

which are known to breed off of the North coast of Iceland. Seal remains form part of the mosaic of coastal resources that have been found at Skutustadir. Further investigation of evidence from coastal resources will allow us to investigate the function and the importance of exchange between the coast and the residents of Lake Myvatn.

The small numbers of various species of mollusca seen throughout the collection are likely not part of the diets of the past Myvatn area residents but may have traveled inland with other coastal products (McGovern, personal communication). Some have hypothesized that seaweed would have been brought inland and burned for salt, and that mollusks such as mussels may have been transported on the root balls of the seaweed. The low numbers of mollusks in this assemblage make it difficult to determine exactly what human activity may have brought them 60 kilometers inland. But they do contribute additional detail, if indirect, to the entire picture of coastal resources including seal and fish species that reached Lake Myvatn settlements.

Skutustadir's continuous stratigraphy and atypical (for inland sites) zooarchaeological finds - chickens, seals, and fresh marine fish - make it an important site to the study of long term economics and human ecology in the region. The recovery of additional material in the 2009 field season will allow further detailed study of the uncommon species found within the assemblage and will enable the detailed study of tooth wear in cattle and caprines.

### *Acknowledgements*

The authors thank the field team at Skutustadir 2008: Augusta Edwald, Oscar Aldred, Jennifer Brown, Val DeFeu, Frank Feeley, Veronique Forbes, George Hambrecht, Aaron Kendall, Christian Koch Madsen, Ian Simpson, the 2008 *Kid's Archaeology/ Forleifaskoli barnana project*, Gerdur Benediktsdottir, the host at Skutustadir and Arni Einarsson. Thanks are also due to George Hambrecht and Amanda Schreiner for assistance in the lab. The research was funded by the US National Science Foundation International Polar Year Arctic Social Sciences Program (Grant # 0732327) and the US NSF Human Dimensions of Global Change program (Grant # 0527732) with additional support from Archaeological Institute Iceland, CUNY Northern Science and Education Center, Myvatn Science Station, Universite Laval, Stirling University, U Colorado Boulder, V. Stefansson Arctic Institute, The Thingeyjarsveit Archaeological Association.

## Fornleifaskóli barnanna



**FIG 27** Krakkar úr Fornleifaskóla barnanna fylgjast með uppgreftri á svæði D

Vorið 2007 var Fornleifaskóli barnanna stofnaður að frumkvæði Unnsteins Ingasonar á Narfastöðum og Baldurs Danielssonar, skólastjóra Litlulaugaskóla. Skólinn er samvinnuverkefni Ferðapjónustunnar á Narfastöðum ehf., Litlulaugaskóla, Brooklyn College og Hunter College í New York, Fornleifastofnunar Íslands ses, Þingeyks sagnagarðs og Hins Þingeyska fornleifafélags. Skólastarfið er enn í mótun, en markmiðið með stofnun skólans er að skapa nýjan vettvang fyrir samstarf ólíkra aðila, innan héraðs og

utan, um fræðslu barna og unglunga um menningararfinn og gildi hans með hliðsjón af árangri fornminjarannsókna í næsta nágrenni nemendanna.

Krakkar úr Fornleifaskólanum heimsóttu uppgroftinn að Skútustöðum tvo morgna 8. og 10. júlí Þau fengu leiðsögn um svæðið auk þess sem þeim var sýnt hvernig borkjarnar voru teknir, sýni fleytt, hvernig hreinsað var ofan af fornleifum og jarðvegur sigtaður. Krakkarnir fengu að sjálf að spreyta sig á að sigta jarðveg og hreinsa svæðið með múrskaiðum undir handleiðslu þeirra fornleifafræðinga sem unnu að rannsókninni og stjórn Ágústu Edwald. Krakkarnir tóku auk þess viðtöl við fornleifafræðinga sem hluta að verkefni við grunnskólann að Litlu-Laugum í Aðaldal. Þann 9. Júlí var einnig farið í vettvangsferð með Fornleifaskólanum að Sveigakoti í Mývatnssveit og þeim voru sýndar leifar bæjarins þar sem hefur verið rannsakaður af fornleifafræðingum. Helstu niðurstöður rannsóknarinnar í Sveigakoti voru ræddar og því landslagi sem talið er að bærinn hafi verið í var lýst fyrir krökkunum.

Krakkarnir og fornleifafræðingarnir sem stóðu að rannsókninni að Skútustöðum voru mjög ánægð með heimsóknina og vettvangsferðina og er stefnt að frekara samstarfi við Fornleifaskólann sumarið 2009.

## Niðurlag

Rannsóknin á Skútustöðum sumarið 2008 leiddi í ljós að öskuhaugurinn aftan, vestan við gamla bæinn og sunnan við íbúðarhúsið á Skútustöðum III er umfangsmikill og geymir leifar allt frá landnámstíð til 20. aldar. Haugurinn er grynstur nyrst og vestast upp við húsið en dýpkar til suðurs og austurs og liggur víða beint ofan á Laxárhrauni yngra sem er um 2000 ára gamalt. Hann er dýpstur um 1.5 m og um 15x35 m stór, austur-vestur. Gjóskulög eru skýr í jarðveginum og hjálpa mjög við aldursgreiningu minjanna.

Gjóska úr Veiðivötnum frá 1717 og 1477 er mjög greinileg á svæðinu auk þess sem greina mátti gjósku úr Heklu 1300 og Kötlu 1262 auk landnámslagsins á svæði E1.

Varðveisla beina er víðast mjög góð á svæðinu og sérstaklega var beinasafnið úr skurði D vel varðveitt og þar fundust meðal annars eggjaskurn og bein úr innra eyra fiska sem vottar um góð varðveisluskilyrði. Leifar lífrænna gripa, s.s. textíls, sem og málmgripa virðist hinsvegar ekki vera góð en lítið var um slíka fundi úr uppgreftrinum. Gler- og leirkerabrot voru algeng á svæðum D og F en engir slíkir gripir fundust á svæðum E1 og E2 enda voru stærstu ruslalögin þaðan eldri en lögin í D og F. Leirkerabrotin og glerið er flest frá 19. öld en einstaka fundir eru eldri (sjá kafla um fundi). Elsti gripurinn sem unnt er að aldursgreina er glerperla úr jarðlagið 063 frá svæði E2 sem hefur verið aldursgreind til víkingaaldar. Einungis einu sinni áður hefur perla af þessari tegund fundist í uppgreftri við bæ en svona perlur finnast oftast í heiðnum gröfum. Perlan hefur líklega ekki verið framleitt í Skandinavíu heldur verið innflutt frá Austur Miðjarðarhafi.

Rannsóknirnar sem þegar hafa verið gerðar á dýrabeinasafninu frá Skútustöðum eru mjög spennandi. Sel og sjávarfiskur virðist hafa verið borðaður í nokkrum mæli og svo virðist sem heimilisfólkið á Skútustöðum hafi fengið ferskan sjávarfisk að borðum ólíkt því sem rannsóknir annars staðar í Mývatnssveit hafa bent þar sem allur sjávarfiskur hefur verið þurrkaður áður en hann var fluttur inn í land. Greining á aldri gripa við slátrun bendir til að kýr hafi aðallega verið haldnar til mjólkurframleiðslu frekar en til kjötframleiðslu en kálfum hefur verið sláttrað mjög ungum. Sauðfé fjölgar í hlutfalli við kýr frá elstu til yngstu laganna sem bendir til að sauðfjárbúskapur hafi fengið aukið vægi, hugsanlega vegna aukins markaðsvirðis ullar en nauðsynlegt er að skoða stærra beinasafn frá Skútustöðum áður en hægt verður að fullyrða að svo sé. Tennur úr fé og nautgripum voru einnig skoðaðar með tilliti til eyðingar á glerjungu til að geta sagt til um hvar fé og nautgripir voru hafðir á beit en til að unnt sé segja til um það með nokkurri vissu vantar fleiri kjálkabein með tönnunum í beinasafnið. Heimilisfólkið á Skútustöðum borðaði auk fjár og nautgripa ýmsar fuglategundir s.s. rjúpu, svan og endur en engin sjófuglabein voru í safninu. Nokkur hænsnabein og svínabein voru í safninu en fleiri slík bein væru æskileg áður en hægt verður að fullyrða að hænsni og svín hafi verið haldin á jörðinni.

### *Frekari rannsóknir*

Stefnt er að því að halda áfram rannsóknum á öskuhauginum á Skútustöðum sumarið 2009 og 2010 og vonast er að þegar þeim uppgröftum er lokið verði orðið til umfangsmikið safn dýrabeina og gripa frá landnámsöld til 20. aldar. Uppgröfturinn sumarið 2008 lofar mjög góðu, sérstaklega með tilliti til



varðveislu beina og staðfest hefur verið að öskuhaugurinn spannar öll skeið Íslandssögunnar frá landnámi til 20. aldar.

Sumarið 2009 er stefnt að að stækka skurð D til austurs niður brekkuna þar sem haugurinn mældist vera dýpstur og opna svæði sem er allt að 80m<sup>2</sup> stórt. Á þann hátt er vonast til að góð varðveisla beina verði tryggð auk þess sem unnt verður að fylgja gjóskulögunum í D til austurs til að tryggja grófa aldursgreiningu jarðlaga á meðan á uppgreftri stendur. Ekki er áætlað að grafa frekar á svæði E1 og E2 né á svæði F en stefnt er að því að athuga bygginguna í skurði F frekar sumarið 2010. Stefnt er að því að vinna að uppgreftrinum frá 8.júní -13. júlí. Fornleifaskóli barnanna mun heimsækja svæðið í annað sinn og líklega í lengri tíma og verður heimsóknin með sama sniði og síðastliðið sumar. Grunnatriði við uppgröft verða kynnt fyrir krökkunum og þau fá að spreyta sig við að teikna jarðlög, hreinsa og sigta.

## Heimildaskrá

Boessneck J. 1969. Osteological differences between Sheep (*Ovis aries* L) and Goat (*Capra hircus* L). In BROTHWELL, D. and HIGGS, E. (eds) *Science in Archaeology*. Thames and Hudson, London; Basic Books, New York, 1963.

Driesch, A von den. 1976. *A Guide to the Measurement of Animal Bones from Archaeological Sites*. Peabody Museum Bulletin 1, Peabody Museum of Archaeology and Ethnology, Harvard University, Cambridge, Massachusetts

Grayson, D. K. 1984. *Quantitative Zooarchaeology*. Academic press, Orlando.

Halstead, Paul, 1998. Mortality Models and Milking: problems of uniformitarianism, optimality, and equifinality reconsidered, *Anthropozoologica* 27: 3-20.

Hillson, Simon , *Teeth*, 1986 Cambridge Manuals in Archaeology, Cambridge University Press.

ÍF X. Íslensk fornrit X, Eyfirðingasögur. 1956. Reykjavík, Hið íslenska fornritafélag.

Karlsson, Gunnar. *Iceland's 1000 Years: The History of a Marginal Society*. Hurst and Co. Publishers. London.

Lyman , R.L. 1996, *Taphonomy*, Cambridge U.P.

McGovern, Thomas H., Orri Vesteinsson, Adolf Fridricksson, Mike Church, Ian Lawson, Ian A. Simpson, Arni Einarsson, Andy Dugmore, Gordon Cook, Sophia Perdikaris, Kevin J. Edwards, Amanda M. Thompson, W. Paul Adderly, Anthony Newton, Gavin Lucas, Ragnar Edvardsson, Oscar Aldred, and Elaine Dunbar. 2007. *Landscapes of Settlement in Northern Iceland: Historical Ecology of*

- Human Impact and Climate Fluctuation on the Millennial Scale. *American Anthropologist* 109(1) 27-51.
- North Atlantic Biocultural Organization Zooarchaeology Working Group 2004. *NABONE Zooarchaeological Recording Package 8th edition*, CUNY, NY.
- Payne, S. 1973. Kill-off patterns in sheep and goats: the mandibles from Asvan Kale. *Journal of Anatolian Studies* 23
- Perdikaris, Sophia and Thomas H. McGovern. 2006. Codfish and Kings, Seals and Subsistence: Norse Marine Resource Use in the North Atlantic. In *Human Impacts of Marine Environments*. UCLA Press Historical Ecology Series.
- Resi, Heid Gjöstein 1990, *Die Wetz- und Schleifsteine aus Haithabu. Bereich über die Ausgrabungen in Haithabu* 28, See pages 78-81, Plates 11-13.
- Sigrid C. J, Hansen. 2009. Whetstones from Viking Age Iceland (in process)

# Viðauki

## Sniðteikningar

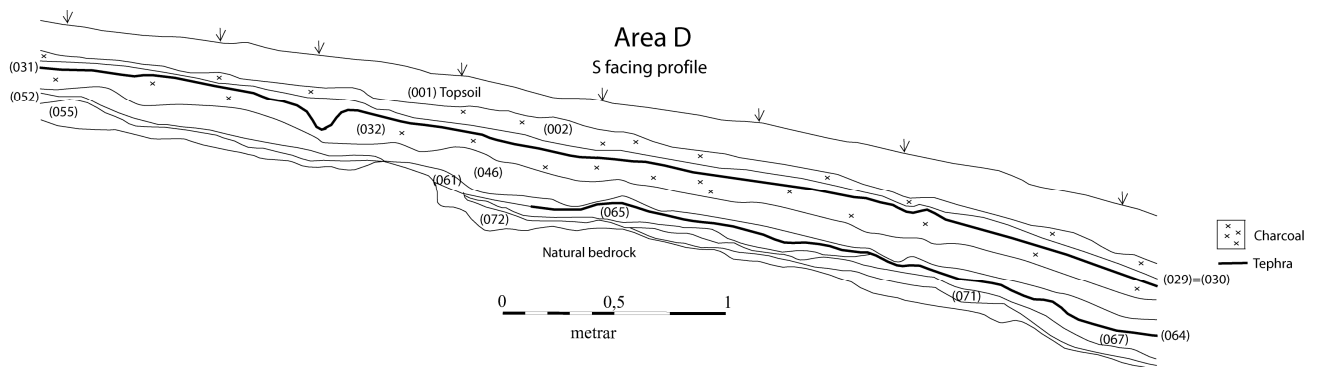
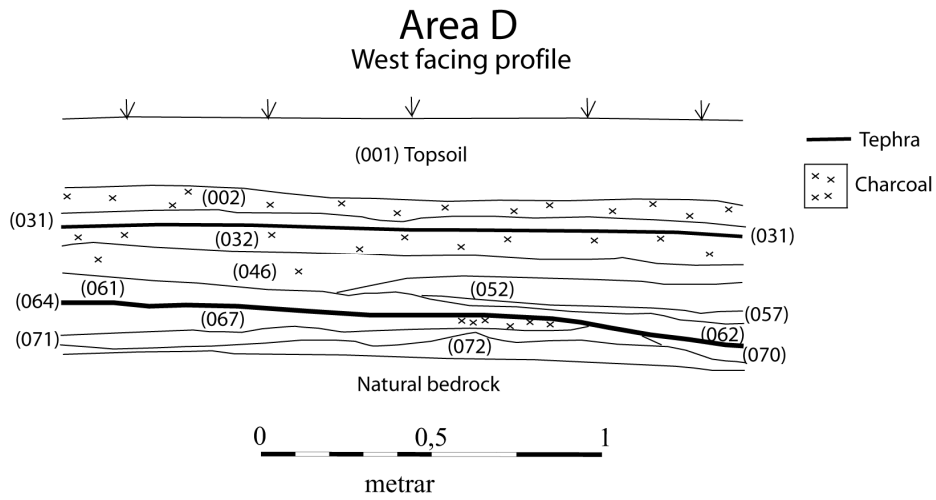
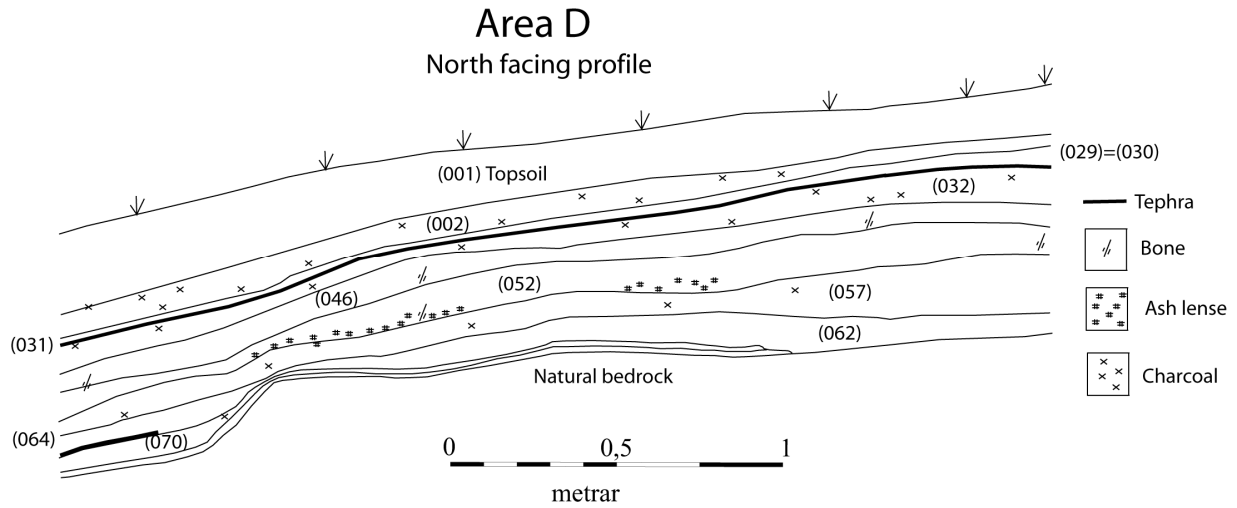

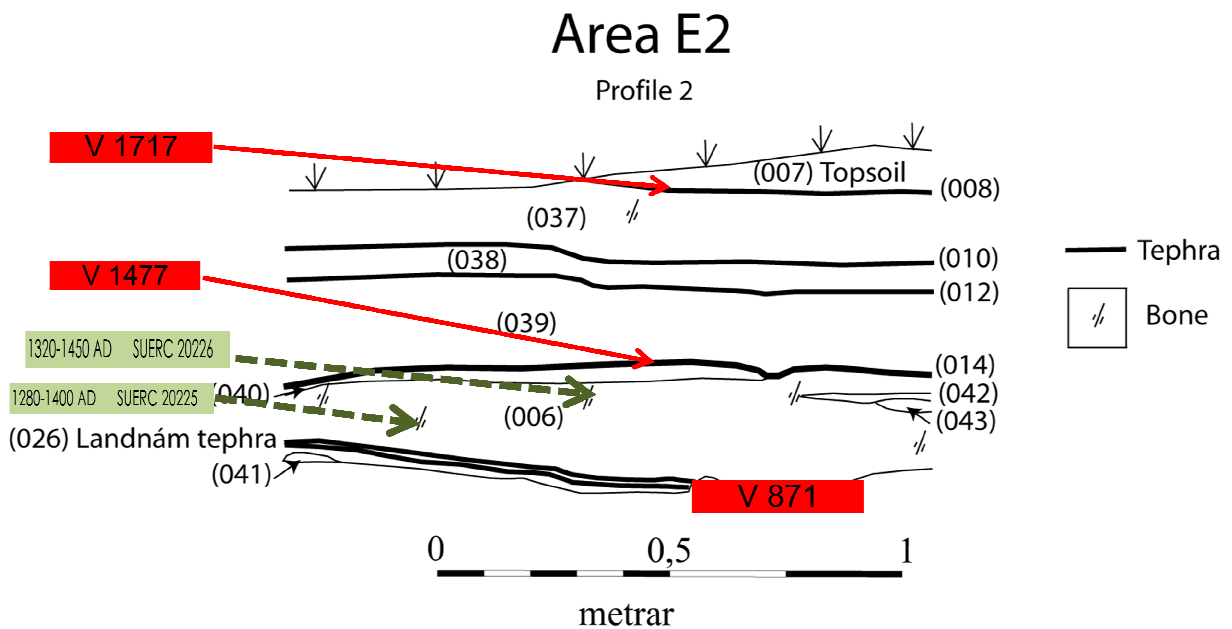
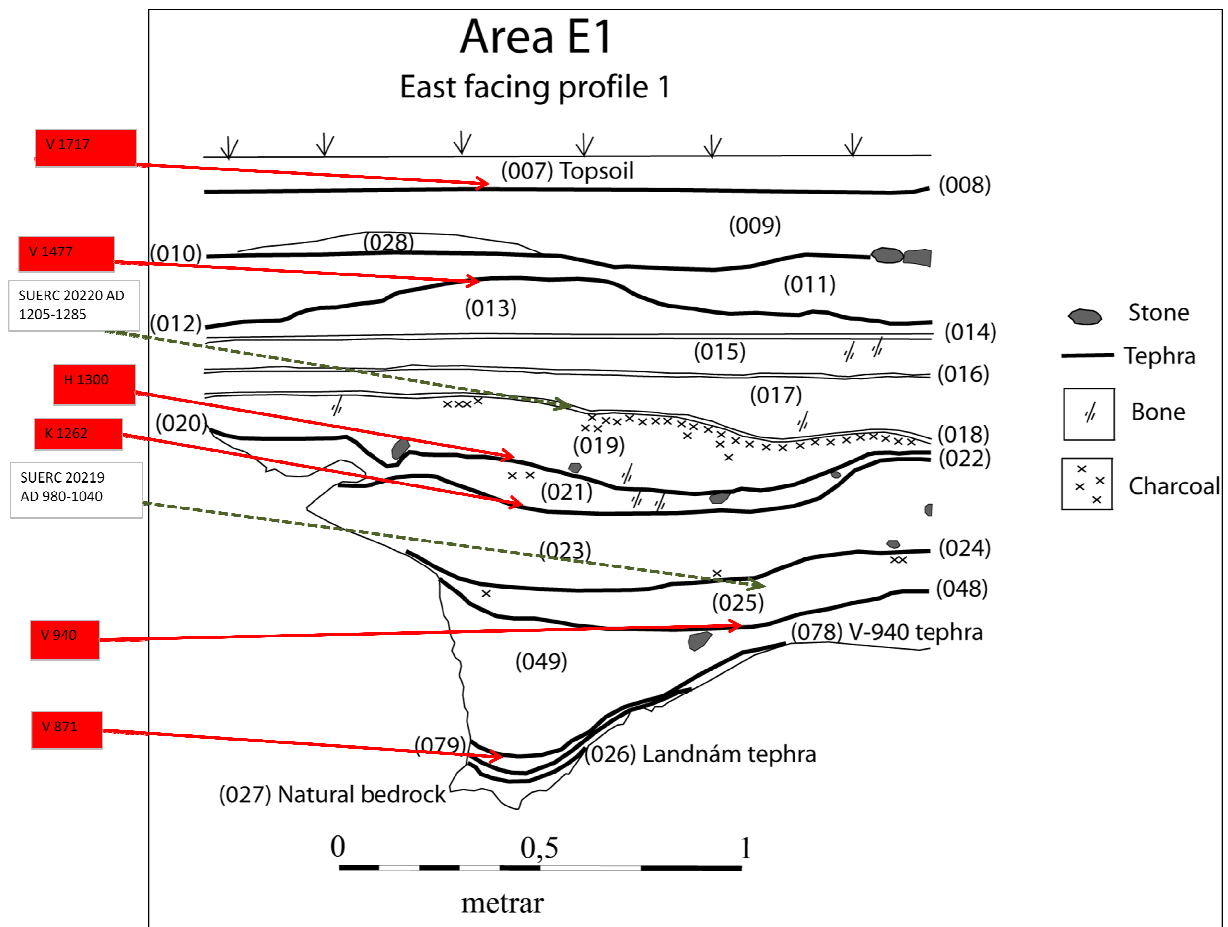

### Area F east facing profile

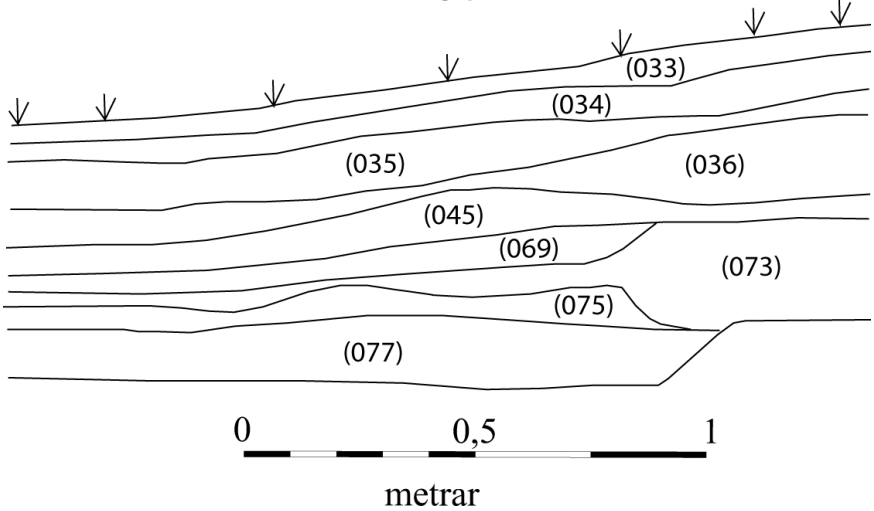

### Area F South facing profile

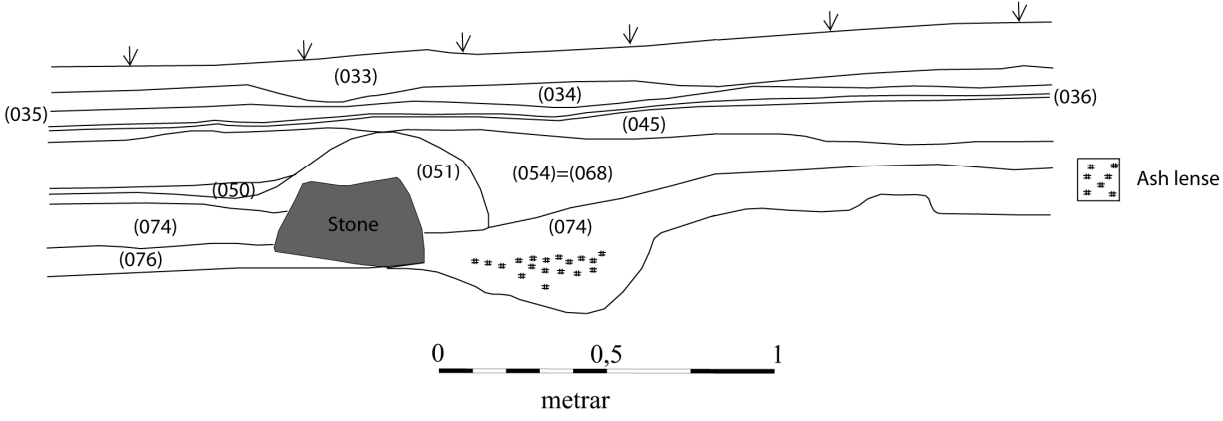

*Jarðlaga skrá (Context register):*

TABLE 5: Context register

<b>Site Name</b>	<b>Year</b>	<b>Code</b>	<b>Area</b>	<b>Context</b>	<b>Context Type</b>	<b>Interpretation</b>
Skutustadir	2008	SKU	D	002	deposit	grey ashy dump
Skutustadir	2008	SKU	D	003	fill	fill of cut 004
Skutustadir	2008	SKU	D	004	cut	ditch or erosion feature- sheep trail?
Skutustadir	2008	SKU	D	005	deposit	windblown silty deposit
Skutustadir	2008	SKU	E2	006	deposit	midden deposit
Skutustadir	2008	SKU	E1	007	deposit	modern turf (above 1717)
Skutustadir	2008	SKU	E1	008	deposit	tephra V1717
Skutustadir	2008	SKU	E1	009	deposit	cultural deposit
Skutustadir	2008	SKU	E1	010	deposit	tephra ?
Skutustadir	2008	SKU	E1	011	deposit	cultural deposit
Skutustadir	2008	SKU	E1	012	deposit	tephra H 1300
Skutustadir	2008	SKU	E1	013	deposit	low density midden
Skutustadir	2008	SKU	E1&E2	014	deposit	tephra V 1477
Skutustadir	2008	SKU	E1	015	deposit	midden layer
Skutustadir	2008	SKU	E1	016	deposit	tephra?
Skutustadir	2008	SKU	E1	017	deposit	midden layer
Skutustadir	2008	SKU	E1	018	deposit	thin ash layer
Skutustadir	2008	SKU	E1	019	deposit	dark rich midden
Skutustadir	2008	SKU	E1	020	deposit	tephra K 1262
Skutustadir	2008	SKU	E1	021	deposit	midden layer
Skutustadir	2008	SKU	E1	022	deposit	tephra ?

<b>Site Name</b>	<b>Year</b>	<b>Code</b>	<b>Area</b>	<b>Context</b>	<b>Context Type</b>	<b>Interpretation</b>
Skutustadir	2008	SKU	E1	023	deposit	midden layer
Skutustadir	2008	SKU	E1	024	deposit	tephra ?
Skutustadir	2008	SKU	E1	025	deposit	midden layer
Skutustadir	2008	SKU	E1	026	deposit	tephra LNS V 871
Skutustadir	2008	SKU	E	027	natural rock	natural pre-occupation surface; lava rocks & stones, v. irregular
Skutustadir	2008	SKU	E	028	Deposit	midden layer
Skutustadir	2008	SKU	D	029	deposit	brown midden deposit
Skutustadir	2008	SKU	D	030	deposit	brown midden deposit
Skutustadir	2008	SKU	D	031	deposit	1717 tephra?
Skutustadir	2008	SKU	D	032	deposit	brown grey midden dump
Skutustadir	2008	SKU	F	033	deposit	turf and topsoil
Skutustadir	2008	SKU	F	034	deposit	grey black midden
Skutustadir	2008	SKU	F	035	deposit	midden
Skutustadir	2008	SKU	F	036	deposit	midden
Skutustadir	2008	SKU	E2	037	deposit	cultural deposit
Skutustadir	2008	SKU	E2	038	deposit	cultural deposit
Skutustadir	2008	SKU	E2	039	deposit	cultural deposit
Skutustadir	2008	SKU	E2	040	deposit	midden layer
Skutustadir	2008	SKU	E2	041	deposit	probably part of LNS
Skutustadir	2008	SKU	E2	042	deposit	cultural deposit
Skutustadir	2008	SKU	E2	043	deposit	cultural deposit
Skutustadir	2008	SKU	D	044	deposit	mixed turf dump

<b>Site Name</b>	<b>Year</b>	<b>Code</b>	<b>Area</b>	<b>Context</b>	<b>Context Type</b>	<b>Interpretation</b>
Skutustadir	2008	SKU	F	045	deposit	black and grey mottled midden deposit
Skutustadir	2008	SKU	D	046	deposit	mottled, grey and orange ashy dump
Skutustadir	2008	SKU	F	047	deposit	peat and midden layer some structural turf
Skutustadir	2008	SKU	E1	048	deposit	tephra
Skutustadir	2008	SKU	E1	049	deposit	midden with lava gravel inclusions
Skutustadir	2008	SKU	F	050	deposit	dark midden layer w. ash lenses
Skutustadir	2008	SKU	F	051	deposit	turf dump
Skutustadir	2008	SKU	D	052	deposit	mottled orange turf dump
Skutustadir	2008	SKU	F	053	deposit	dump of large stones under dump of displaced structural turf
Skutustadir	2008	SKU	F	054	deposit	white grey ashy dump w/lenses of turf bits
Skutustadir	2008	SKU	D	055	deposit	mixed ash and turf dump with a bit of peat
Skutustadir	2008	SKU	D	056	deposit	mixed black and red peat ash
Skutustadir	2008	SKU	D	057	deposit	mixed orange turf and green tephra
Skutustadir	2008	SKU	E2	058	deposit	midden layer
Skutustadir	2008	SKU	E2	059	deposit	midden layer
Skutustadir	2008	SKU	E2	060	deposit	midden layer



<b>Site Name</b>	<b>Year</b>	<b>Code</b>	<b>Area</b>	<b>Context</b>	<b>Context Type</b>	<b>Interpretation</b>
Skutustadir	2008	SKU	D	061	deposit	brown blown silt
Skutustadir	2008	SKU	D	062	deposit	mixed turf dump
Skutustadir	2008	SKU	E2	063	deposit	midden layer
Skutustadir	2008	SKU	D	064	deposit	midden layer
Skutustadir	2008	SKU	D	065	deposit	turf dump
Skutustadir	2008	SKU	D	066	deposit	turf dump
Skutustadir	2008	SKU	D	067	deposit	brown silt with charcoal inclusions
Skutustadir	2008	SKU	F	068	deposit	midden layer
Skutustadir	2008	SKU	F	069	deposit	midden layer
Skutustadir	2008	SKU	D	070	deposit	ash dump?
Skutustadir	2008	SKU	D	071	deposit	turf dump
Skutustadir	2008	SKU	D	072	deposit	gritty deposit on natural (may be natural)
Skutustadir	2008	SKU	F	073	deposit	black and grey gravelly deposit
Skutustadir	2008	SKU	F	074	deposit	turf deposit
Skutustadir	2008	SKU	F	075	deposit	mixed turf and charcoal deposit
Skutustadir	2008	SKU	F	076	deposit	turf deposit
Skutustadir	2008	SKU	F	077	deposit	midden lying against wall
Skutustadir	2008	SKU	E1	078	deposit	tephra layer V 940
Skutustadir	2008	SKU	E1	079	deposit	cultural deposit
Skutustadir	2008	SKU	F	080	structure	stone and turf wall

*Fundaskrá (Finds register):*

TABLE 6: Finds register

<b>Finds no</b>	<b>Former finds no</b>	<b>Area</b>	<b>Context</b>	<b>Type</b>	<b>Material Type (Basic)</b>	<b>Sub Material</b>	<b>Quantity</b>	<b>Weight (g)</b>
001		F	033	Worked bone	Bone		3	90,06
002		F	033	Window	Glass		1	2,39
003		F	033	Vessel	Glass		8	9,61
004		F	033	Nail	Metal	Iron	2	7,81
005		F	033	Pottery	Ceramic		27	103,89
006		F	033	Whetstone	Stone		1	89,33
007		F	035	Pottery	Ceramic		2	3,44
008		F	035	Vessel	Glass		1	0,80
009		F	035	Hook	Metal	Iron	1	0,85
010		D	032	Nail	Metal	Iron	9	58,31
011		F	047	Pottery	Ceramic		1	0,40
012		F	047	Slag	Slag		1	1,66
013		D	032	Window	Glass		3	2,01
014		D	032	Clay pipe	Ceramic		1	1,23
015		D	002	Vessel	Glass		7	13,94
016		D	002	Window	Glass		9	5,69
017		D	002	Nail	Metal	Iron	6	20,51
018		D	002	Pottery	Ceramic		23	20,41
019		D	001	Vessel	Glass		2	1,19

<b>Finds no</b>	<b>Former finds no</b>	<b>Area</b>	<b>Context</b>	<b>Type</b>	<b>Material Type (Basic)</b>	<b>Sub Material</b>	<b>Quantity</b>	<b>Weight (g)</b>
020		D	001	Window	Glass		3	7,58
021		D	001	Nail	Metal	Iron	1	5,25
022		D	001	Pottery	Ceramic		24	88,77
023		E1	007	Nail	Metal	Iron	1	6,07
024		E1	019	Indet	Wool		1	0,05
025		E1	013	Nail	Metal	Iron	1	2,76
026		D	046	Button?	Metal	Lead alloy	1	3,85
027		D	046	Button	Metal	Copper alloy	1	2,72
028		D	046	Pin	Metal	Copper alloy/lead alloy	1	0,52
029		D	055	Hammer	Stone		1	159,83
030		D	052	Pottery	Ceramic		2	2,03
031		D	055	Clothing fastener	Metal	Copper alloy	1	0,26
032		D	055	Clay pipe	Ceramic		1	4,44
033		D	052	Nail	Metal	Iron	6	33,46
034		D	046	Window	Glass		4	3,30
035		D	046	Vessel	Metal	Copper alloy	1	23,26
036		D	046	Vessel	Glass		3	3,21
037		D	052	Manuport	Stone		2	1,32
038		D	046	Clay pipe	Ceramic		2	6,41

<b>Finds no</b>	<b>Former finds no</b>	<b>Area</b>	<b>Context</b>	<b>Type</b>	<b>Material Type (Basic)</b>	<b>Sub Material</b>	<b>Quantity</b>	<b>Weight (g)</b>
039		D	052	Vessel	Glass		1	0,50
040		F	047	Pottery	Ceramic	MISSING		
041		F	047	Nail	Metal	Iron	1	3,64
042		DELETED	DELETED	DELETED	DELETED	DELETED	DELETED	DELETED
043		F	036	Clay pipe	Ceramic		5	6,75
044		E2	059	Staple	Metal	Iron	1	2,38
045		F	036	Window	Glass		7	2,45
046		F	036	Vessel	Glass		7	5,55
047		F	050	Nail	Metal	Iron	2	14,88
048		F	050	Window	Glass		1	0,50
049		F	050	Pottery	Ceramic		4	2,00
050		F	045	Manuport	Stone		3	13,89
051		F	045	Window	Glass		1	0,29
052		F	045	Fragment	Metal	Copper alloy	1	0,76
053		F	045	Clay pipe	Ceramic		2	8,78
054		E2	059	Nail	Metal	Iron	3	9,15
055		E2	059	Manuport	Stone		1	1,75
056		D	057	Fish hook	Metal	Iron	1	1,83
057		D	057	Window	Glass		1	1,01
058		D	057	Whetstone	Stone	Schist	1	20,33
059		D	071	Manuport	Stone		1	0,61

<b>Finds no</b>	<b>Former finds no</b>	<b>Area</b>	<b>Context</b>	<b>Type</b>	<b>Material Type (Basic)</b>	<b>Sub Material</b>	<b>Quantity</b>	<b>Weight (g)</b>
060		D	060	Indet	Stone	Steatite	1	7,57
061		E2	060	Vessel?	Metal	Copper alloy	3	6,29
062		E2	060	Slag	Slag		1	23,40
063		E2	060	Loop	Metal	Iron	1	22,21
064		E2	060	Ring	Metal	Iron	1	6,32
065		E2	060	Indet	Metal	Iron	1	4,77
066		D	061	Nail	Metal	Iron	2	1,31
067		D	061	Clothing fastener	Metal	Copper alloy	2	1,51
068		F	062	Bar	Metal	Iron	1	64,66
069		F	069	Pottery	Ceramic		7	27,20
070		F	069	Fitting	Metal	Copper alloy	1	0,90
071		F	069	Hook	Metal	Iron	2	2,09
072		E2	063	Indet	Metal	Iron	2	0,64
073		E2	063	Indet	Metal	Iron	1	0,65
074		E2	063	Nail	Metal	Copper alloy	1	0,84
075		E2	063	Bead	Glass/gold		1	0,39
076		E2	063	Nail	Metal	Iron	1	5,32
077		F	075	Nail	Metal	Iron	3	31,17
078		F	075	Ring	Metal	Iron	1	5,17

<b>Finds no</b>	<b>Former finds no</b>	<b>Area</b>	<b>Context</b>	<b>Type</b>	<b>Material Type (Basic)</b>	<b>Sub Material</b>	<b>Quantity</b>	<b>Weight (g)</b>
079		F	073	Nail	Metal	Iron	3	11,97
080		F	075	Manuport	Stone/glass	Obsidian	1	6,12
081		F	074	Nail	Metal	Iron	1	1,72
082		F	077	Whetstone	Stone		1	8,32
083		F	077	Manuport?	Stone?	Obsidian?	1	0,54
084		F	075	Nail	Metal	Iron	2	5,39
085		F	077	Nail	Metal	Iron	1	4,01
086		F	075	Rove	Metal	Copper alloy	1	4,77
087		F	077	Sheeting	Metal	Copper alloy	1	2,39
088		F	077	Pottery	Ceramic		1	4,04
089		F	077	Manuport	Stone		2	0,98
090		F	077	Clothing fastener	Metal	Copper alloy	1	0,27
091		F	033	Sheeting	Metal	Lead alloy	2	7,69
092		F	035	Nail?	Metal	Iron	1	1,78
093		F	035	Clothing fastener	Metal	Iron	1	0,29
094		F	035	Mount	Metal	Copper alloy	1	0,56
095	043	F	036	Pottery	Ceramic		24	11,15
096	043	F	045	Pottery	Ceramic		3	18,25
097	052	F	045	Nail	Metal	Iron	3	17,89

<b>Finds no</b>	<b>Former finds no</b>	<b>Area</b>	<b>Context</b>	<b>Type</b>	<b>Material Type (Basic)</b>	<b>Sub Material</b>	<b>Quantity</b>	<b>Weight (g)</b>
098	052	F	045	Clench bolt	Metal	Copper alloy	1	13,94
099	052	F	047	Pottery	Ceramic		2	2,54
100	012	F	047	Nail	Metal	Iron	1	3,53
101	012	F	047	Sheeting	Metal	Copper alloy	1	2,13
102	071	F	069	Nail	Metal	Iron		27,56
103	071	F	069	Knife	Metal	Iron	1	8,66
104	063	E2	060	Indet	Metal	Iron	3	4,89
105	063	E2	060	Nail	Metal	Iron	1	9,05
106	018	D	002	Clay pipe	Ceramic		1	0,83
107	017	D	002	Indet	Metal	Iron	2	1,09
108	017	D	002	Indet	Metal	Iron	1	1,88
109	013	D	032	Vessel	Glass		4	2,31
110	014	D	032	Pottery	Ceramic		1	0,56
111	046	D	046	Nail	Metal	Iron	5	37,40
112	035	D	046	Indet	Metal	Iron	1	2,99
113	038	D	046	Pottery	Ceramic		1	0,68
114	039	D	052	Piece	Glass		2	0,98
115	033	D	052	Clench bolt	Metal	Iron	2	18,05
116	032	D	055	Pottery	Ceramic		3	11,27
117	031	D	055	Clench bolt	Metal	Copper alloy	2	6,92

<b>Finds no</b>	<b>Former finds no</b>	<b>Area</b>	<b>Context</b>	<b>Type</b>	<b>Material Type (Basic)</b>	<b>Sub Material</b>	<b>Quantity</b>	<b>Weight (g)</b>
118	031	D	055	Ring	Metal	Lead alloy	1	3,22
119	031	D	055	Nail	Metal	Iron	5	28,86
120	031	D	055	Clench bolt	Metal	Iron	2	23,51
121	031	D	055	Hook	Metal	Iron	1	21,84
122	031	D	055	Pin	Metal	Iron	1	2,87
123	056	D	057	Nail	Metal	Iron	10	57,36
124	068	F	062	Nail	Metal	Iron	3	12,11
125	068	F	062	Rove	Metal	Iron	3	14,98
126	068	F	062	Hook	Metal	Iron	1	3,18
127		F	068	Handle	Composite	Iron and wood	1	



*Beinaskrá (Bone register):*

TABLE 7: Bone register

<b>No.</b>	<b>Area</b>	<b>Context</b>	<b># of bags</b>
1	D	002	2
2	D	001	2
3	D	003	1
4	D	005	1
5	D	032	1
6	D	019	1
7	D	033	2
8	D	013	1
9	E	006	1
10	E	006	1
11	E	007	1
12	D	032	2
13	E	035	2
14	D	044	1
15	F	036	1
16	D	046	2
17	D	052	3
18	D	056	1
19	F	047	1

<b>No.</b>	<b>Area</b>	<b>Context</b>	<b># of bags</b>
20	F	045	1
21	D	055	2
22	F	051	1
23	F	050	1
24	F	036	1
25	E2	014	1
26	D	057	3
27	D	057	1
28	E2	059	3
29	E2	006	2
30	F	009	2
31	D	072	1
32	E2	060	2
33	D	061	1
34	D	062	2
35	F	068	1
36	D	071	1
37	F	054	1
38	D	067	1

<b>No.</b>	<b>Area</b>	<b>Context</b>	<b># of bags</b>
39	D	070	1
40	D	065	1
41	E2	063	1
42	D	066	1
43	F	077	1
44	VOID		
45	F	077	2

<b>No.</b>	<b>Area</b>	<b>Context</b>	<b># of bags</b>
46	F	076	1
47	F	075	2
48	E2	063	1
49	F	074	1
50	F	073	1
51	E2	006	1

Harris Matrix

Svæði D

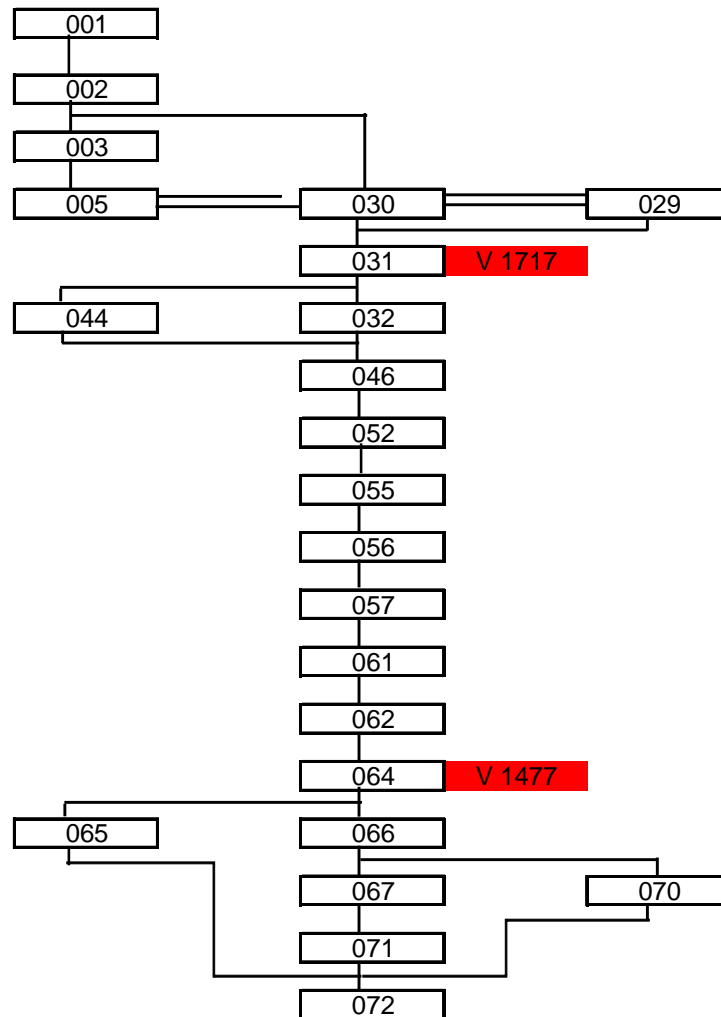

## Svæði E1 & E2

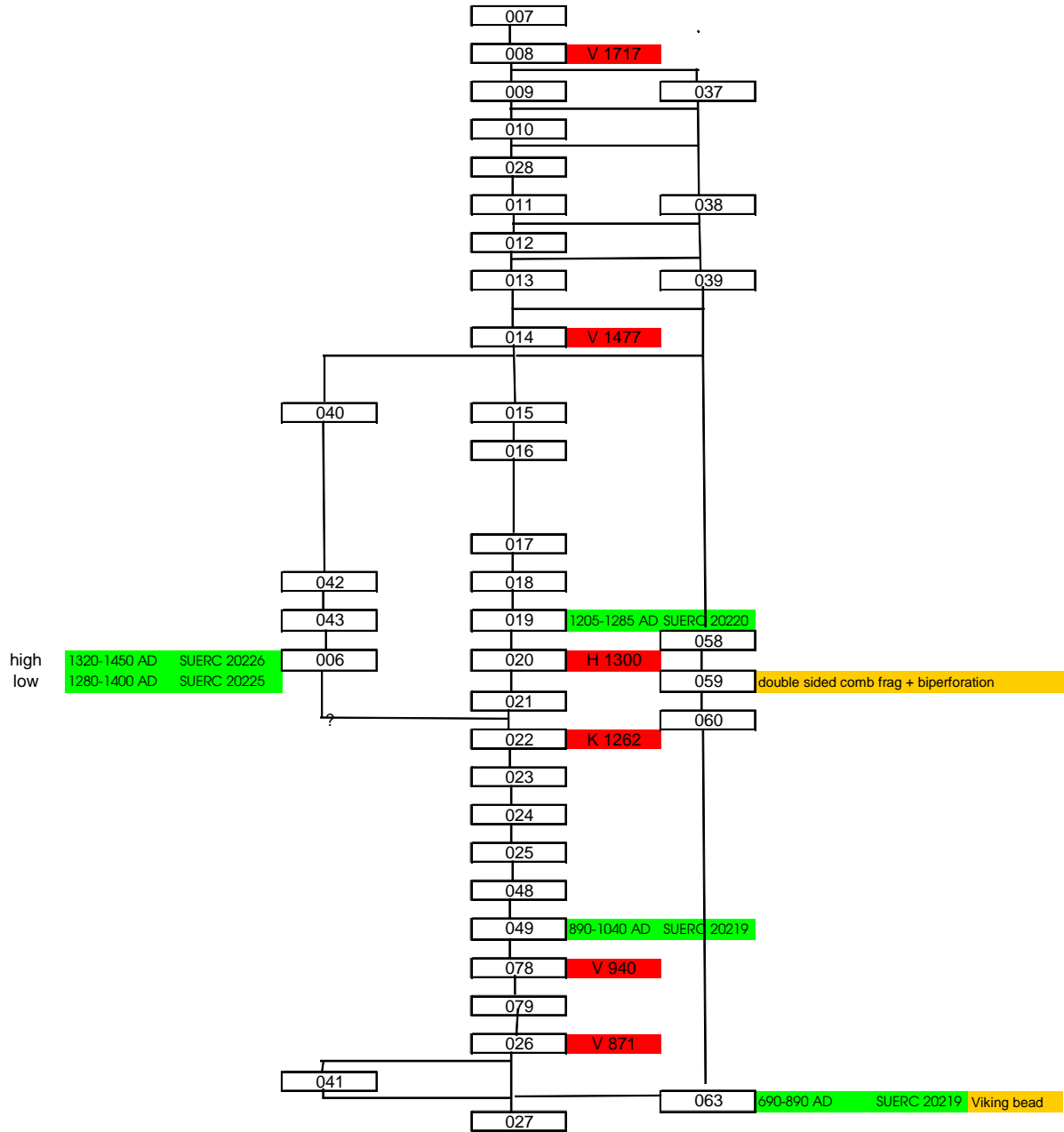

Svæði F

