

TRÚNAÐARMÁL

11/2000

TRÚNAÐARMÁL

FORTROLIG
i h.t. **Beskyttelsesinstruksen,**
jfr. offentlighetslovens
§ nr.

GEOLOGY and HYDROCARBON

POTENTIAL of

THE JAN MAYEN RIDGE

Appendices 4 and 5



Oljedirektoratet

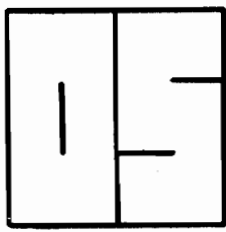

Orkustofnun

ORKUSTOFNUN

nr. 6

TRÚGÁRMAÐ

FORTROLIG

i h.t. Beskyttelsesinstruksen,
jfr. offentlighetslovens

§ nr.

**GEOLOGY and HYDROCARBON
POTENTIAL of
THE JAN MAYEN RIDGE**

Maps and profiles

Appendices 4 and 5

Authors:

Karl Gunnarsson,
NEA, Reykjavik

Morten Sand,

NPD, Stavanger

Steinar T. Gudlaugsson,

Dept. of Geology,

Univ. of Oslo



Oljedirektoratet

OD-89-91

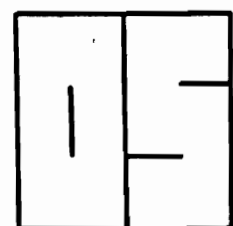

Orkustofnun

OS-89036 / JHD-07

- Appendix 4 a** Geophysical survey grid on the Jan Mayen Ridge acquired by NEA and NPD in 1985 and NPD in 1979. Scale 1 : 500 000
(Reduced versions in Fig 1.2 and 1.3)
- b** Main structural and volcanic features of the Jan Mayen Ridge.
Scale 1 : 500 000.
(Reduced version in Fig 2.13)
- c** Isochrone map of reflector Purple.
Scale 1 : 500 000.
(Reduced version in Fig 2.14)
- d** Isochrone map of reflector Red.
Scale 1 : 500 000.
(Reduced version in Fig 2.20)
- e** Isochrone map of reflector Blue.
Scale 1 : 500 000.
(Reduced version in Fig 2.22)
- f** Isopach map of total sediment thickness (in TWT) above reflector Purple. Scale 1 : 500 000.
(Reduced version in Fig 2.15)
- g** Isopach map of the Purple-Red megasequence. Scale 1 : 500 000.
(Reduced version in Fig 2.21)
- h** Isopach map of Red-Blue megasequence. Scale 1 : 500 000.
(Reduced version in Fig 2.23)
- i** Isopach map of the sequence above reflector Blue. Scale 1 : 500 000.

(Reduced version in Fig 2.24)

Appendix 5 a Line drawings of four seismic dip lines (JM-85-4,10,12 and 17) across the Jan Mayen Ridge.

(Reduced version in Fig 2.16)

b Line drawing of a composite seismic strike line (composed of lines JM-85-1226 and 326) along the eastern flank of the Jan Mayen Ridge. (Reduced version in Fig 2.17)

c Evolution of the Jan Mayen Ridge.

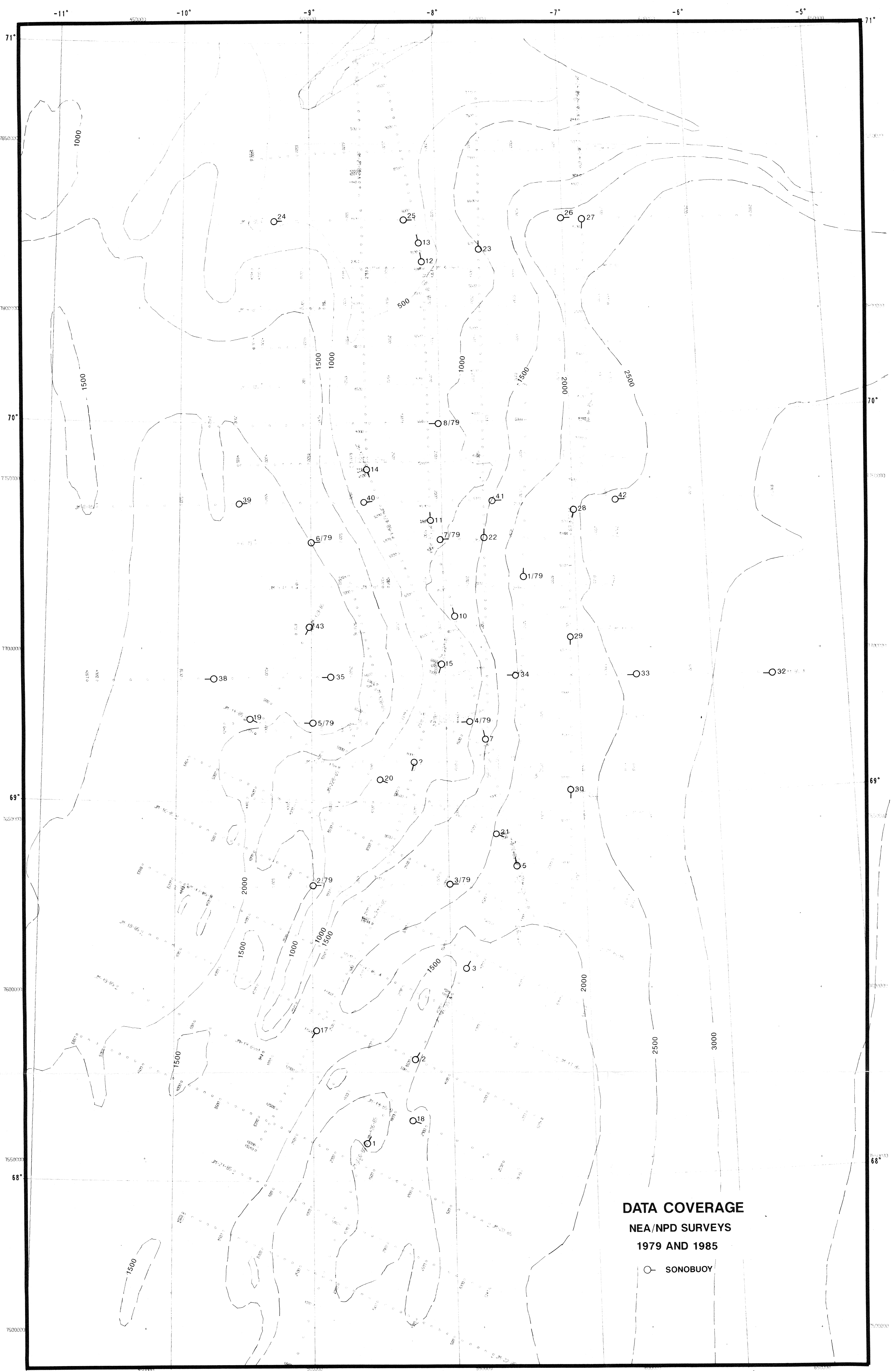

**DATA COVERAGE
NEA/NPD SURVEYS
1979 AND 1985**

○ SONOBUOY

RN-0184/8
Appendix 4a

Projeksjon : UTM
Datum : ED 50
Ellipsoide : Hayford 1924 (International)
Sentral Meridian : 9°00'

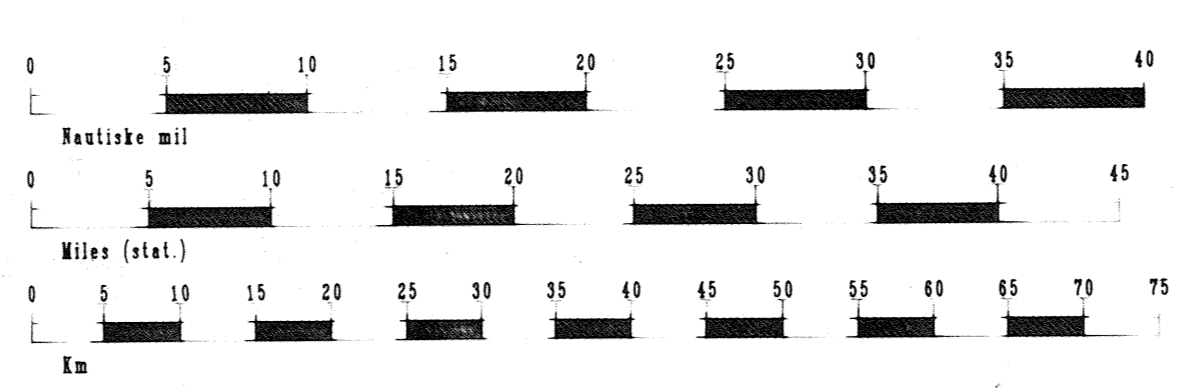

SKALA 1: 500.000





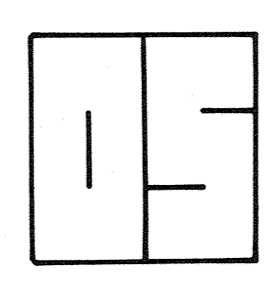

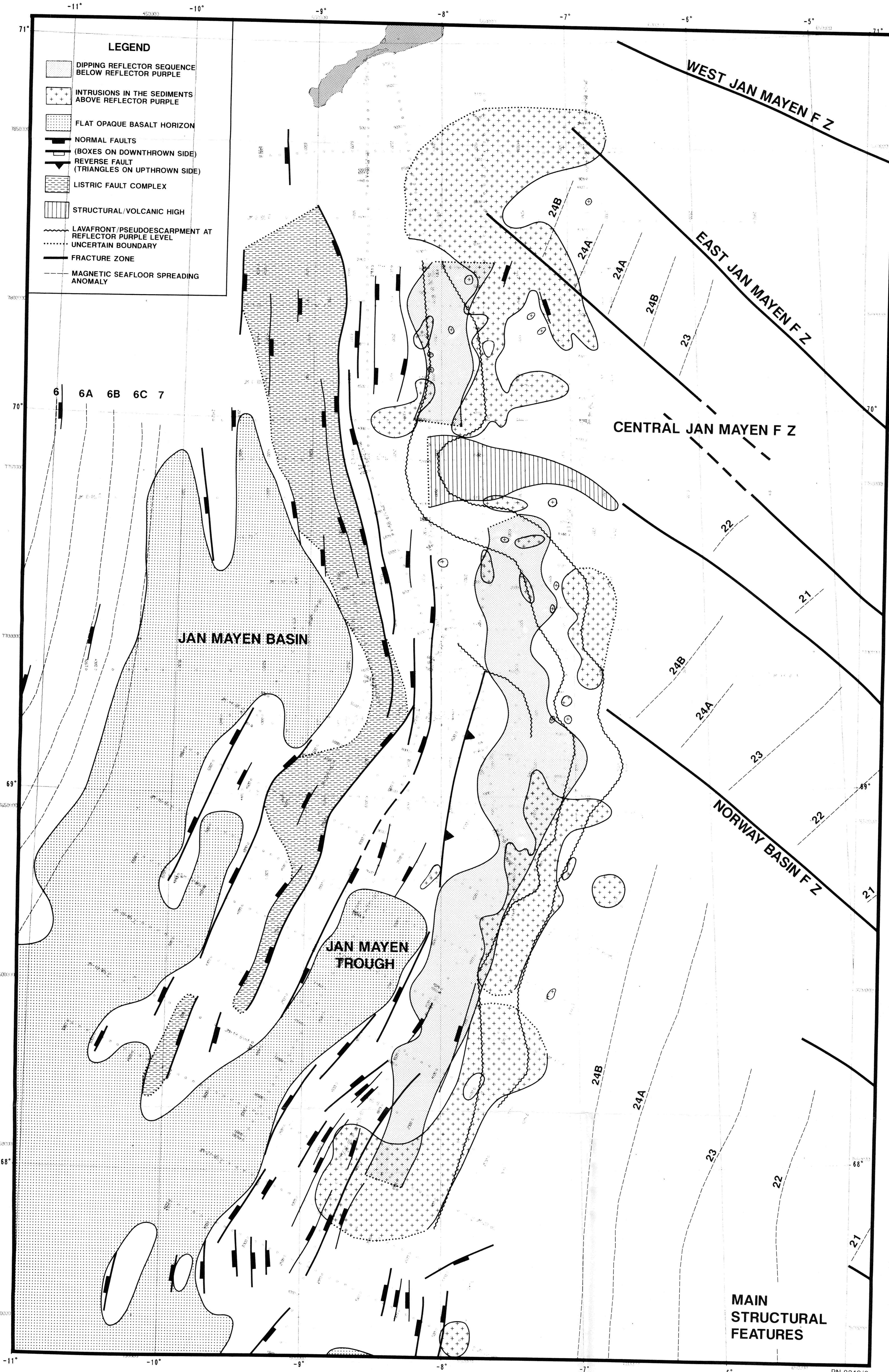

**OLJEDIREKTORATET
NORWEGIAN PETROLEUM DIRECTORATE**

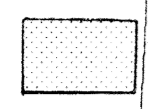
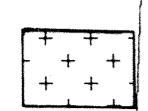
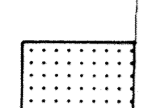

**ORKUSTOFNUN
NATIONAL ENERGY AUTHORITY**

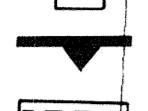
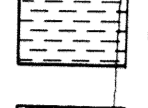

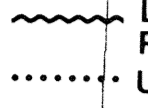
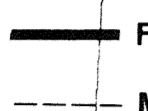
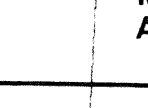
LEGEND

-  DIPPING REFLECTOR SEQUENCE BELOW REFLECTOR PURPLE
-  INTRUSIONS IN THE SEDIMENTS ABOVE REFLECTOR PURPLE
-  FLAT OPAQUE BASALT HORIZON
-  NORMAL FAULTS (BOXES ON DOWNTHROWN SIDE)
-  REVERSE FAULT (TRIANGLES ON UPTHROWN SIDE)
-  LISTRIC FAULT COMPLEX
-  STRUCTURAL/VOLCANIC HIGH
-  LAVAFRONT/PSEUDOESCARPMENT AT REFLECTOR PURPLE LEVEL
-  UNCERTAIN BOUNDARY
-  FRACTURE ZONE
-  MAGNETIC SEAFLOOR SPREADING ANOMALY

JAN MAYEN BASIN

JAN MAYEN TROUGH

WEST JAN MAYEN F Z

EAST JAN MAYEN F Z

CENTRAL JAN MAYEN F Z

NORWAY BASIN F Z

MAIN STRUCTURAL FEATURES

Projeksjon: UTM
 Datum: ED 50
 Ellipsoide: Hayford 1924 (International)
 Sentral Meridian: 9°00'

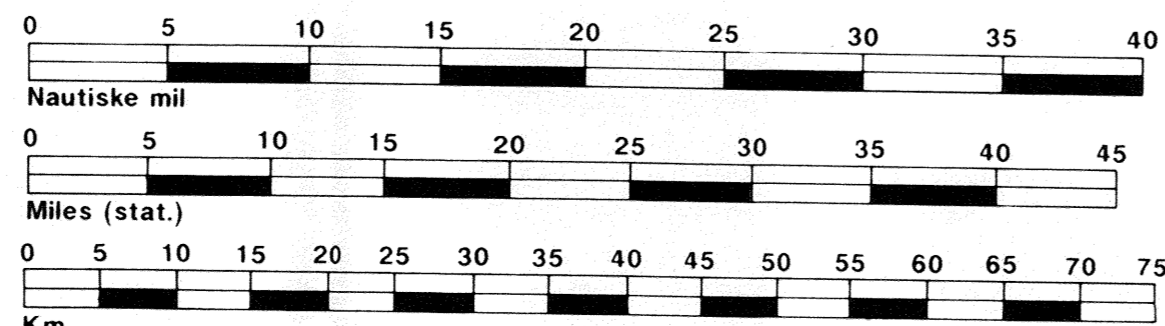

SKALA 1 : 500.000



OLJEDIREKTORATET
 NORWEGIAN PETROLEUM DIRECTORATE

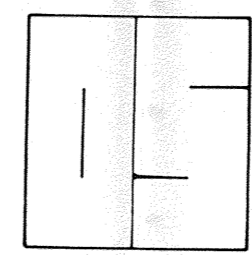

ORKUSTOFNUN
 NATIONAL ENERGY AUTHORITY

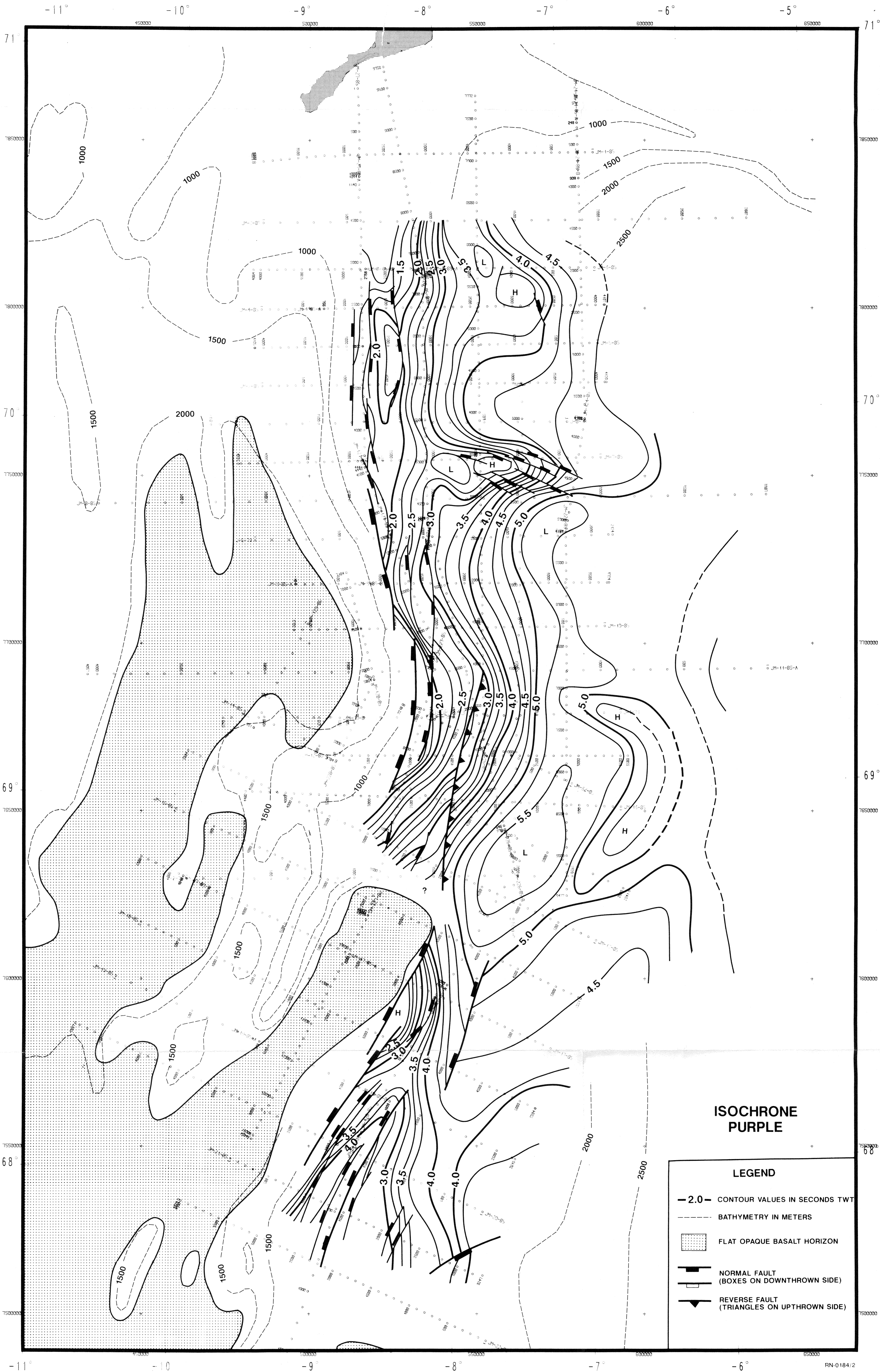

**ISOCHRONE
PURPLE**

LEGEND

- 2.0 - CONTOUR VALUES IN SECONDS TWT
- BATHYMETRY IN METERS
- FLAT OPAQUE BASALT HORIZON
- NORMAL FAULT
(BOXES ON DOWNTHROWN SIDE)
- REVERSE FAULT
(TRIANGLES ON UPTHROWN SIDE)

Projeksjon : UTM
Datum : ED 50
Ellipsoide : Hayford 1924 (International)
Sentral Meridian : 9°00'

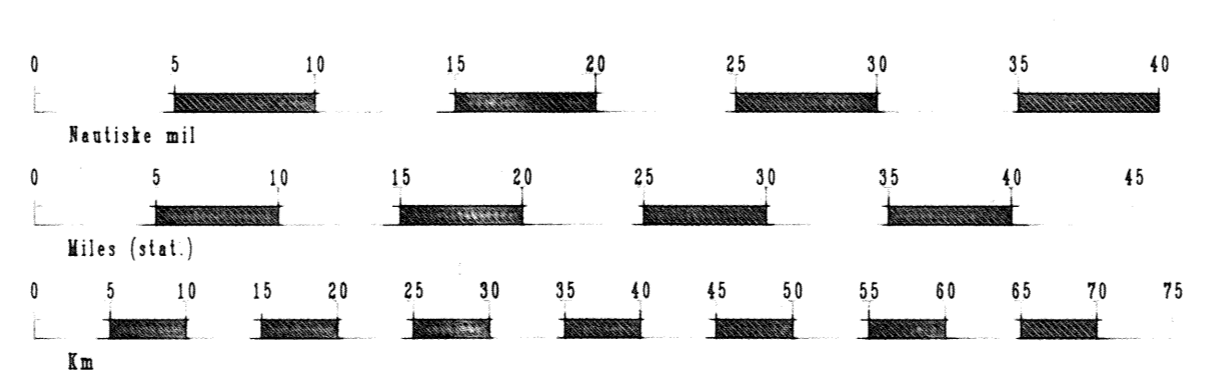

OLJEDIREKTORATET
NORWEGIAN PETROLEUM DIRECTORATE

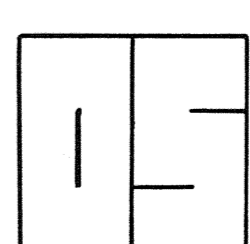

ORKUSTOFNUN
NATIONAL ENERGY AUTHORITY

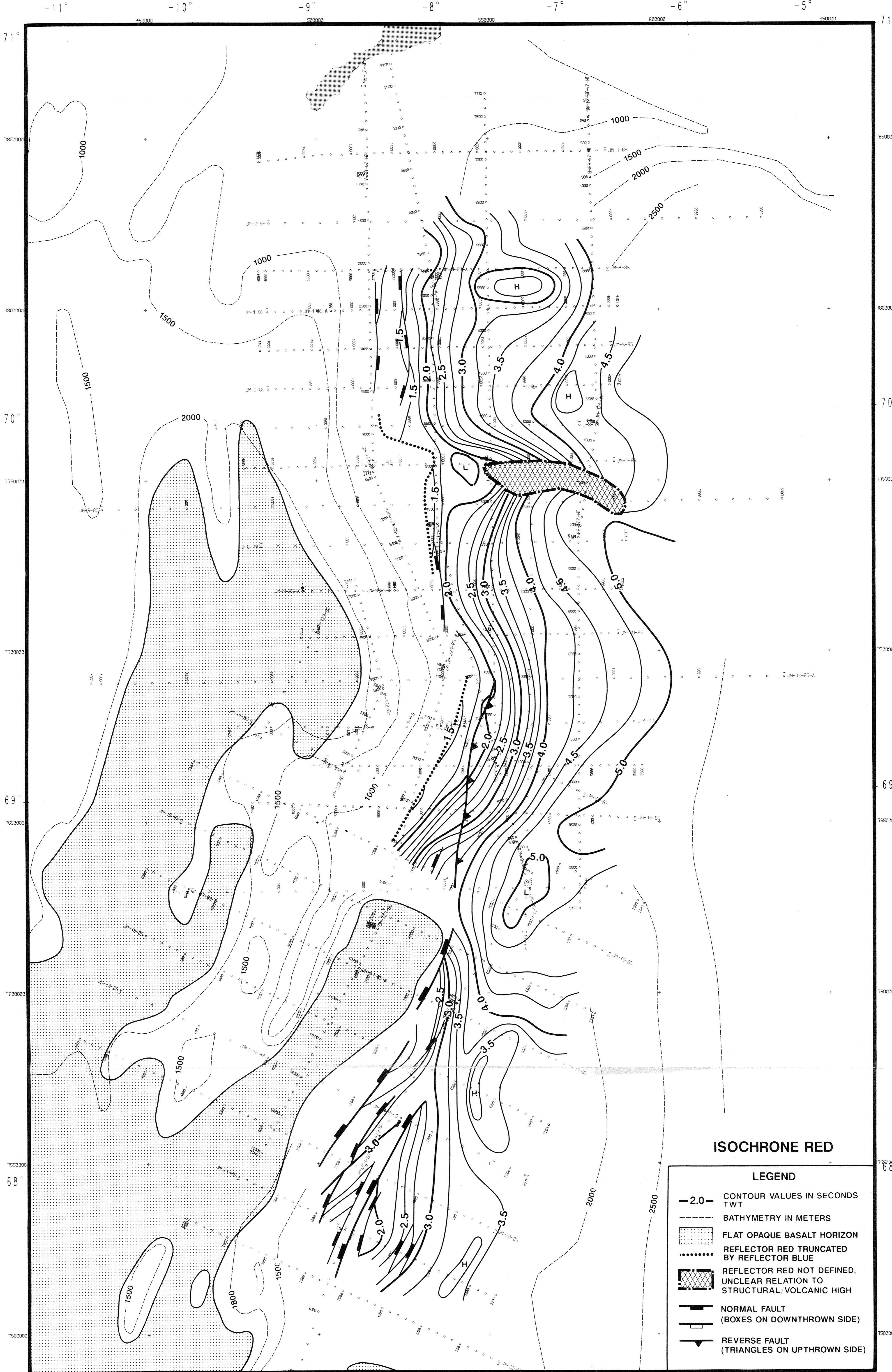

ISOCHRONE RED

| LEGEND | |
|--------|---|
| | CONTOUR VALUES IN SECONDS TWT |
| | BATHYMETRY IN METERS |
| | FLAT OPAQUE BASALT HORIZON |
| | REFLECTOR RED TRUNCATED BY REFLECTOR BLUE |
| | REFLECTOR RED NOT DEFINED, UNCLEAR RELATION TO STRUCTURAL/VOLCANIC HIGH |
| | NORMAL FAULT (BOXES ON DOWNTHROWN SIDE) |
| | REVERSE FAULT (TRIANGLES ON UPTHROWN SIDE) |

Projeksjon : UTM
 Datum : ED 50
 Ellipsoide : Hayford 1924 (International)
 Sentral Meridian : 9° 00'

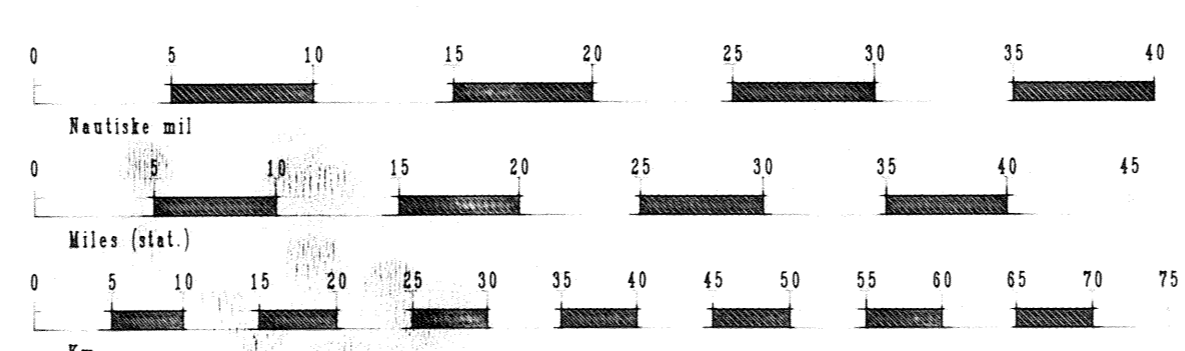

SKALA 1: 500.000



OLJEDIREKTORATET
 NORWEGIAN PETROLEUM DIRECTORATE

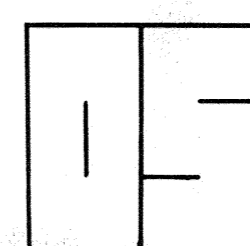

ORKUSTOFNUN
 NATIONAL ENERGY AUTHORITY

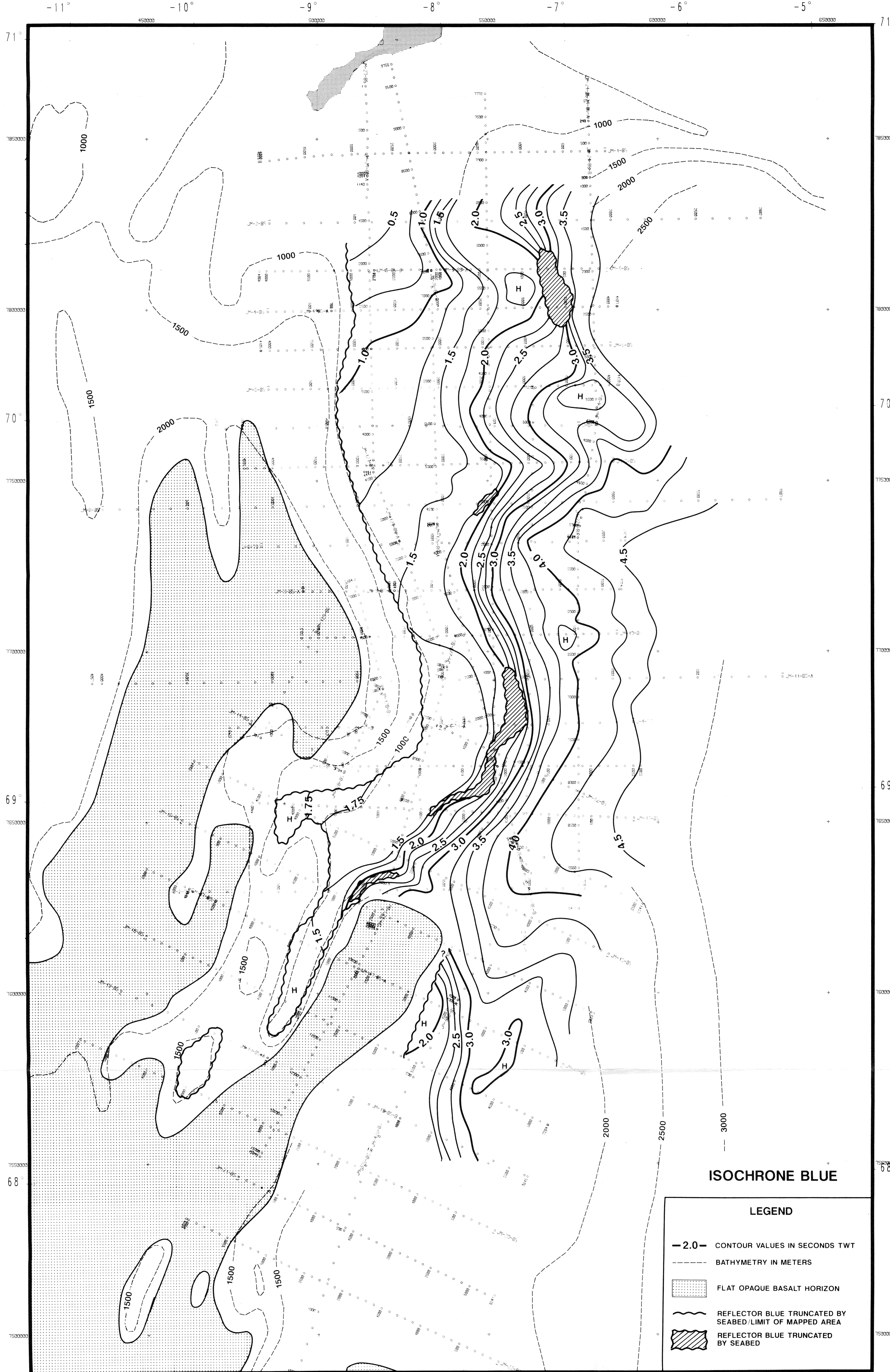

ISOCHRONE BLUE

LEGEND

- 2.0 -** CONTOUR VALUES IN SECONDS TWT
- BATHYMETRY IN METERS
- [Stippled pattern] FLAT OPAQUE BASALT HORIZON
- [Wavy line] REFLECTOR BLUE TRUNCATED BY SEABED/LIMIT OF MAPPED AREA
- [Hatched pattern] REFLECTOR BLUE TRUNCATED BY SEABED

Projeksjon : UTM
 Datum : ED 50
 Ellipsoide : Hayford 1924 (International)
 Sentral Meridian : 9°00'

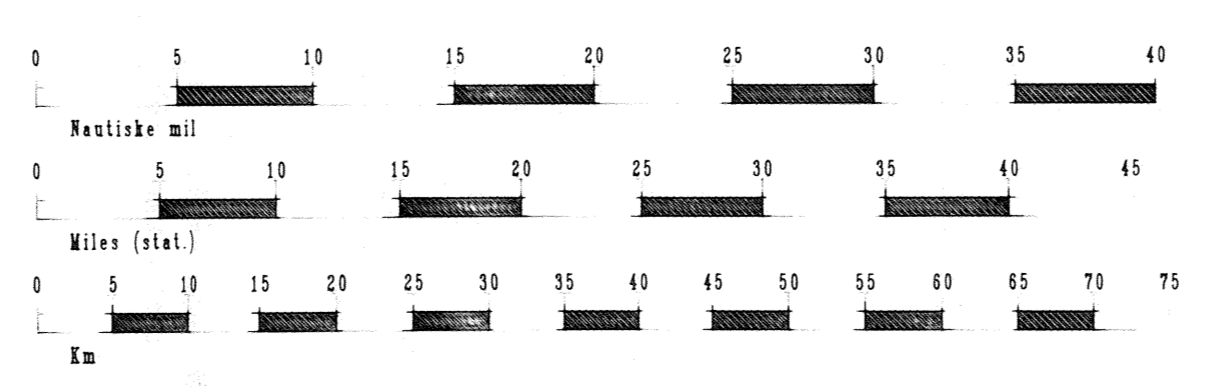

SKALA 1: 500.000



OLJEDIREKTORATET
 NORWEGIAN PETROLEUM DIRECTORATE

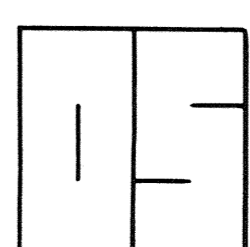

ORKUSTOFNUN
 NATIONAL ENERGY AUTHORITY

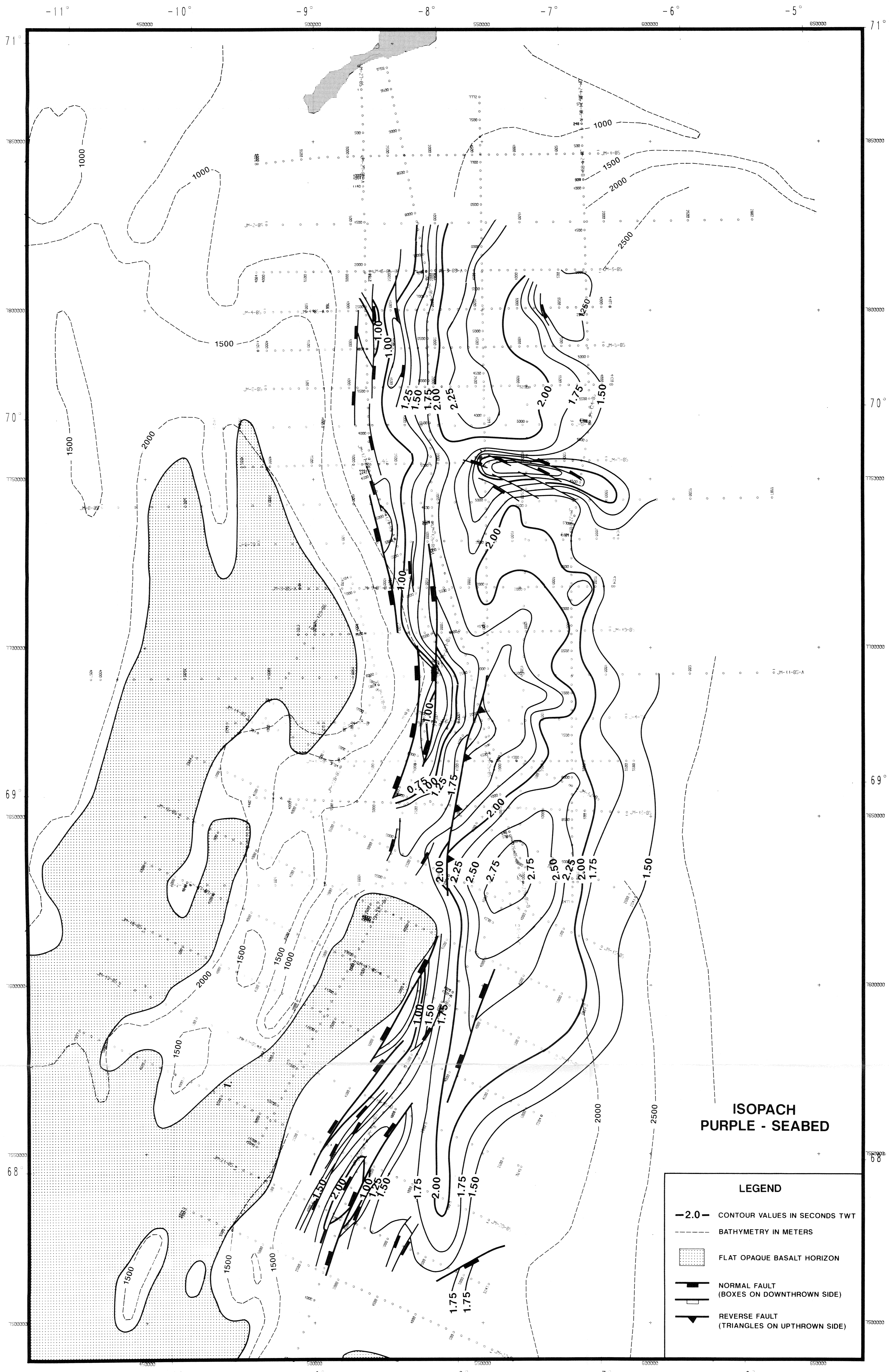

**ISOPACH
PURPLE - SEABED**

| LEGEND | |
|--------|---|
| | CONTOUR VALUES IN SECONDS TWT |
| | BATHYMETRY IN METERS |
| | FLAT OPAQUE BASALT HORIZON |
| | NORMAL FAULT (BOXES ON DOWNTHROWN SIDE) |
| | REVERSE FAULT (TRIANGLES ON UPTHROWN SIDE) |

Projeksjon : UTM
Datum : ED 50
Ellipsoide : Hayford 1924 (International)
Sentral Meridian : 9° 00'

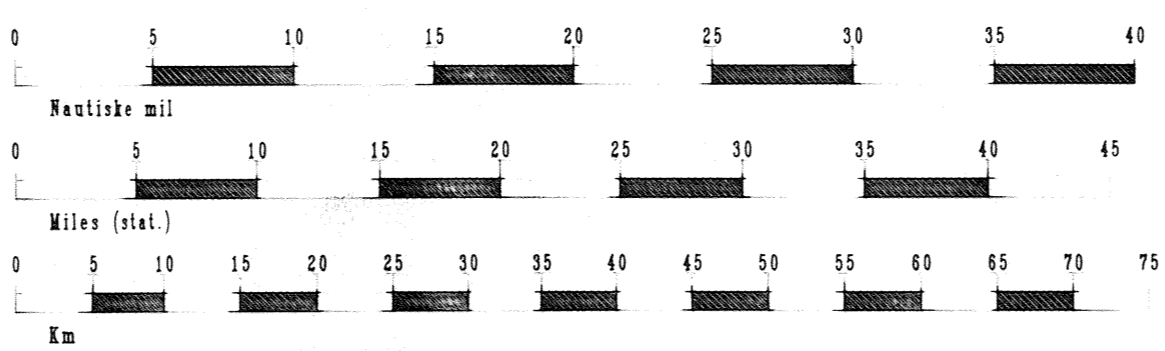

SKALA 1: 500.000



OLJEDIREKTORATET
NORWEGIAN PETROLEUM DIRECTORATE

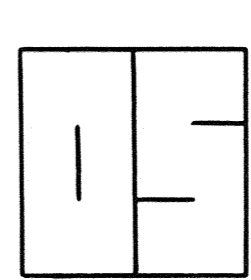

ORKUSTOFNUN
NATIONAL ENERGY AUTHORITY

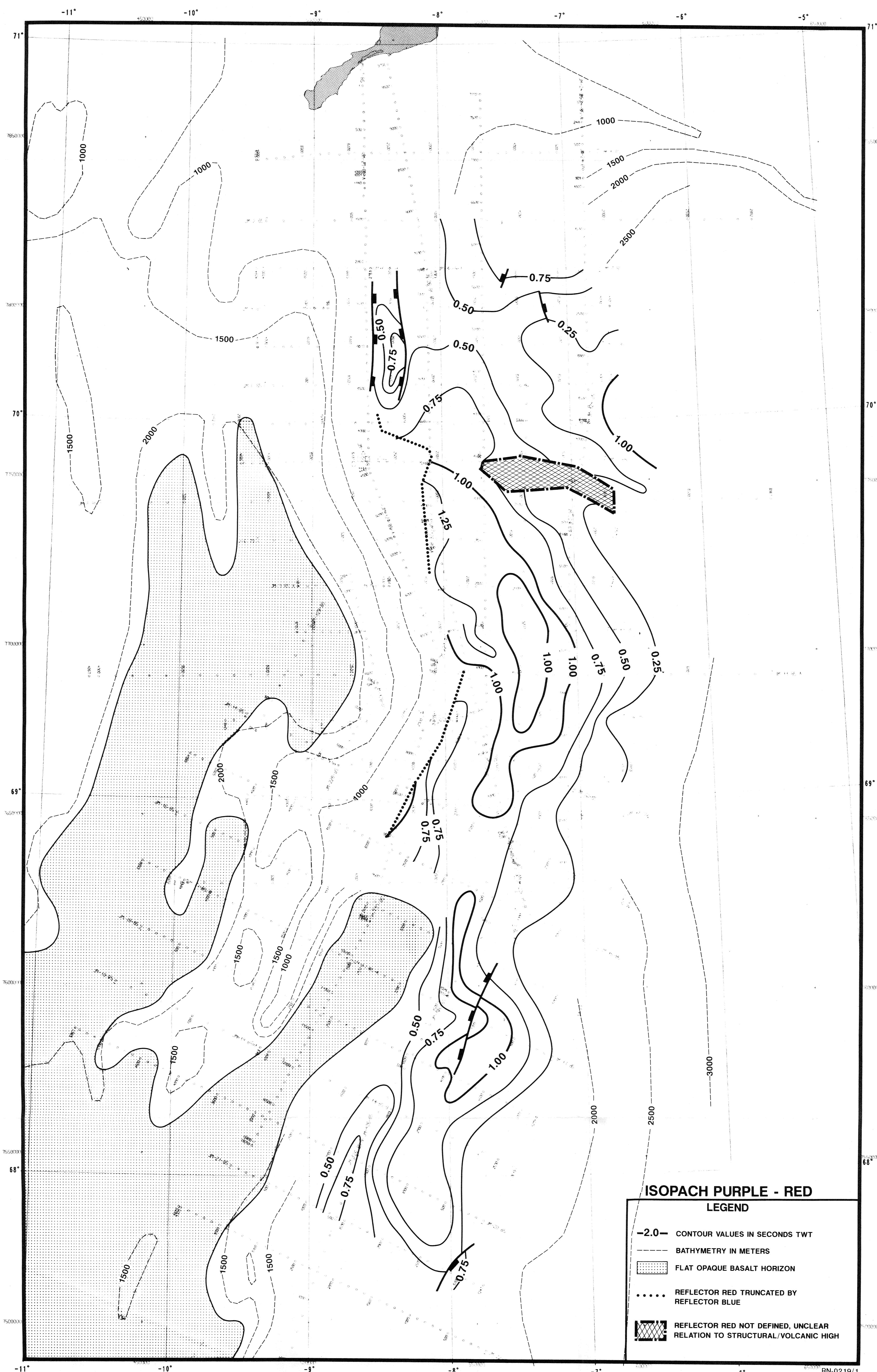

**ISOPACH PURPLE - RED
LEGEND**

- 2.0-** CONTOUR VALUES IN SECONDS TWT
- BATHYMETRY IN METERS
- [Hatched Box] FLAT OPAQUE BASALT HORIZON
- [Dotted Line] REFLECTOR RED TRUNCATED BY REFLECTOR BLUE
- [Cross-hatched Box] REFLECTOR RED NOT DEFINED, UNCLEAR RELATION TO STRUCTURAL/VOLCANIC HIGH

RN-0219/1
Appendix 4g

Projeksjon: UTM
Datum: ED 50
Ellipsoide: Hayford 1924 (International)
Sentral Meridian: 9°00'

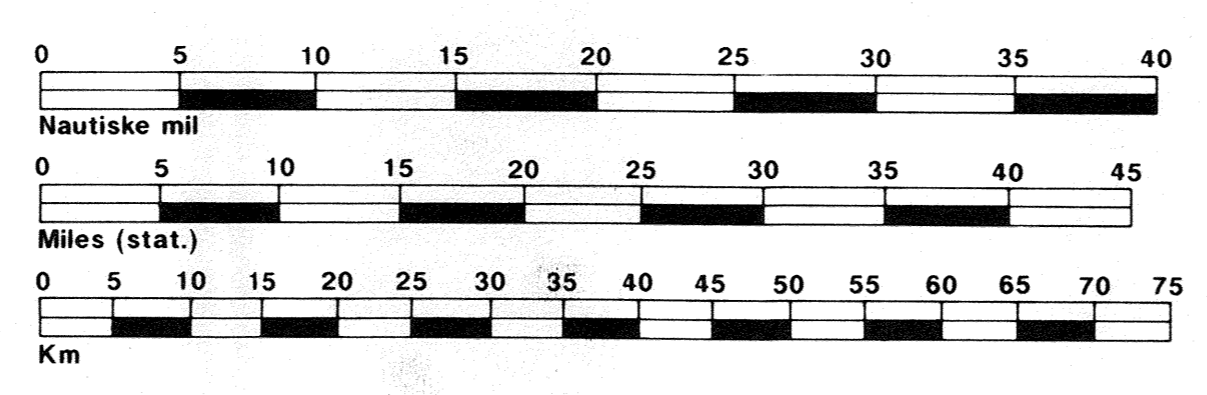

SKALA 1 : 500.000

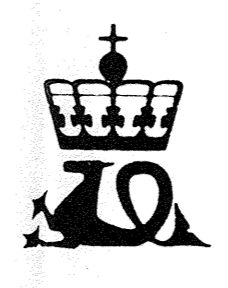

OLJEDIREKTORATET
NORWEGIAN PETROLEUM DIRECTORATE

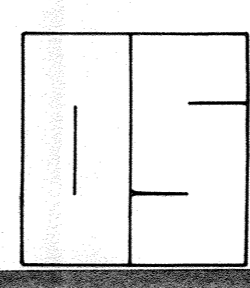

ORKUSTOFNUN
NATIONAL ENERGY AUTHORITY

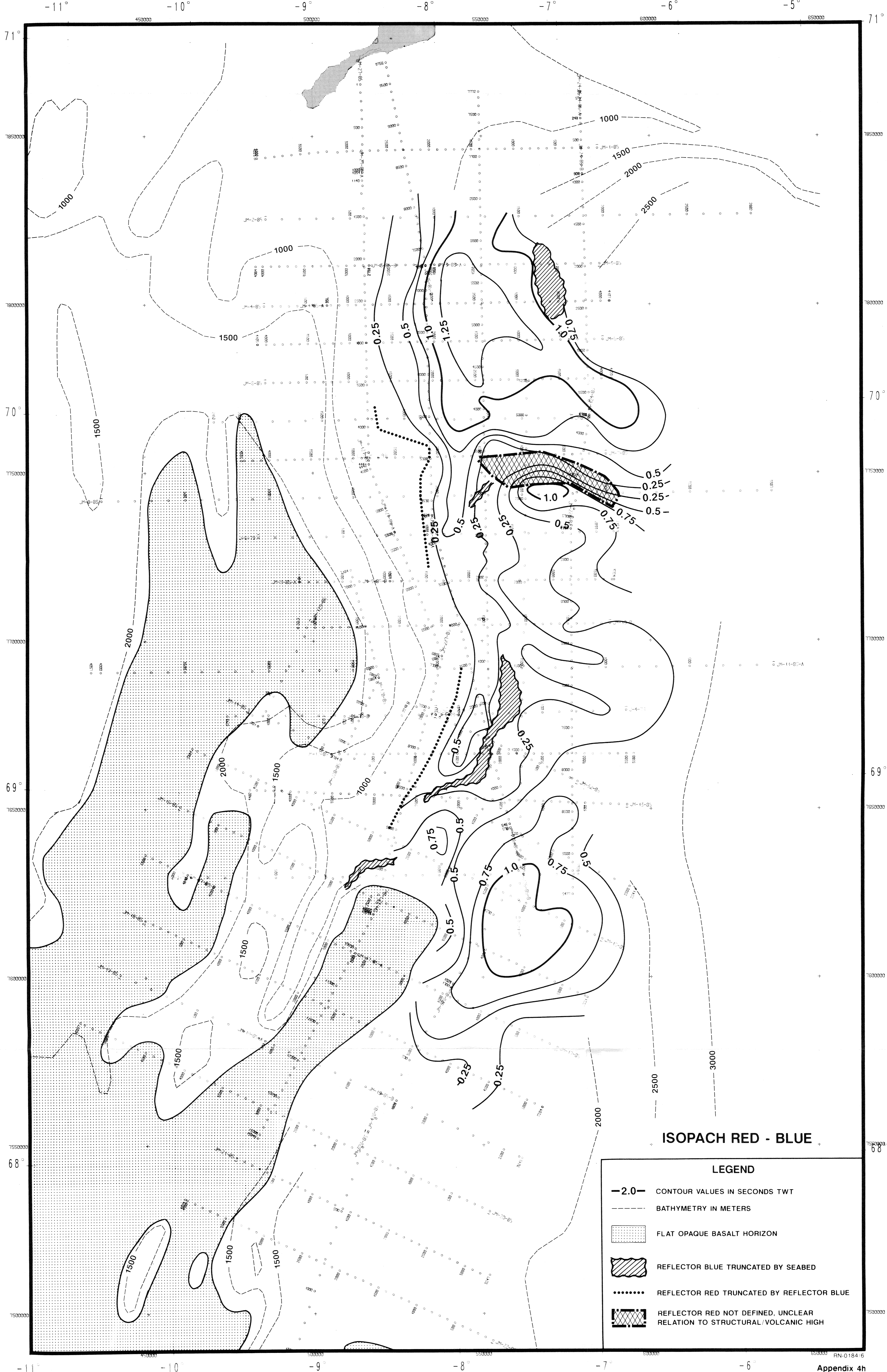

ISOPACH RED - BLUE

LEGEND

- 2.0-** CONTOUR VALUES IN SECONDS TWT
- - - BATHYMETRY IN METERS
- [Dotted pattern] FLAT OPAQUE BASALT HORIZON
- [Hatched pattern] REFLECTOR BLUE TRUNCATED BY SEABED
- [Dotted line] REFLECTOR RED TRUNCATED BY REFLECTOR BLUE
- [Cross-hatched pattern] REFLECTOR RED NOT DEFINED, UNCLEAR RELATION TO STRUCTURAL/VOLCANIC HIGH

Projeksjon : UTM
 Datum : ED 50
 Ellipsoide : Hayford 1924 (International)
 Sentral Meridian : 9° 00'

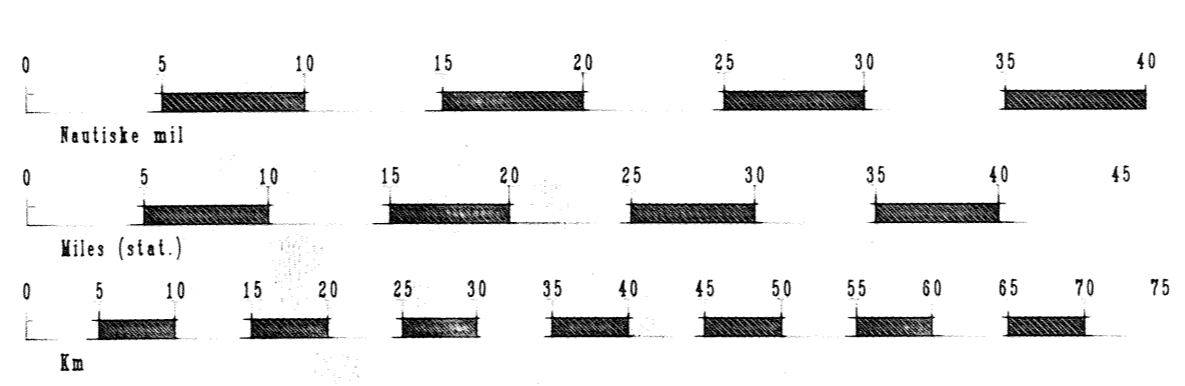

SKALA 1: 500.000



OLJEDIREKTORATET
 NORWEGIAN PETROLEUM DIRECTORATE

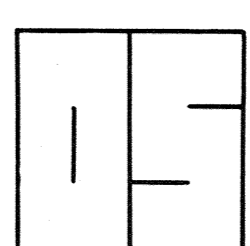

ORKUSTOFNUN
 NATIONAL ENERGY AUTHORITY

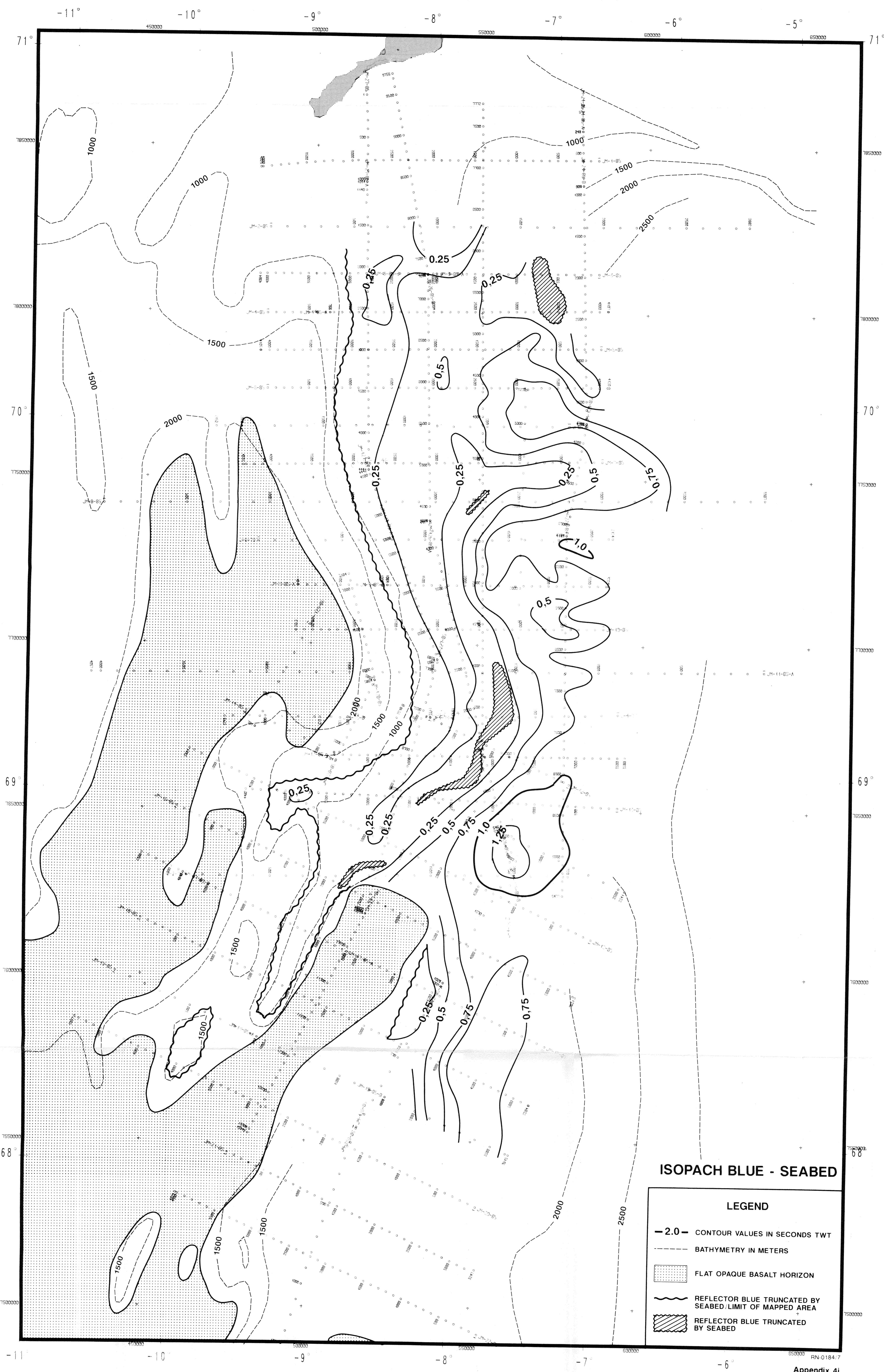

ISOPACH BLUE - SEABED

LEGEND

- 2.0 -** CONTOUR VALUES IN SECONDS TWT
- - - BATHYMETRY IN METERS
- [Stippled Box] FLAT OPAQUE BASALT HORIZON
- [Wavy Line] REFLECTOR BLUE TRUNCATED BY SEABED / LIMIT OF MAPPED AREA
- [Hatched Box] REFLECTOR BLUE TRUNCATED BY SEABED

Projeksjon : UTM
 Datum : ED 50
 Ellipsoide : Hayford 1924 (International)
 Sentral Meridian : 9° 00'

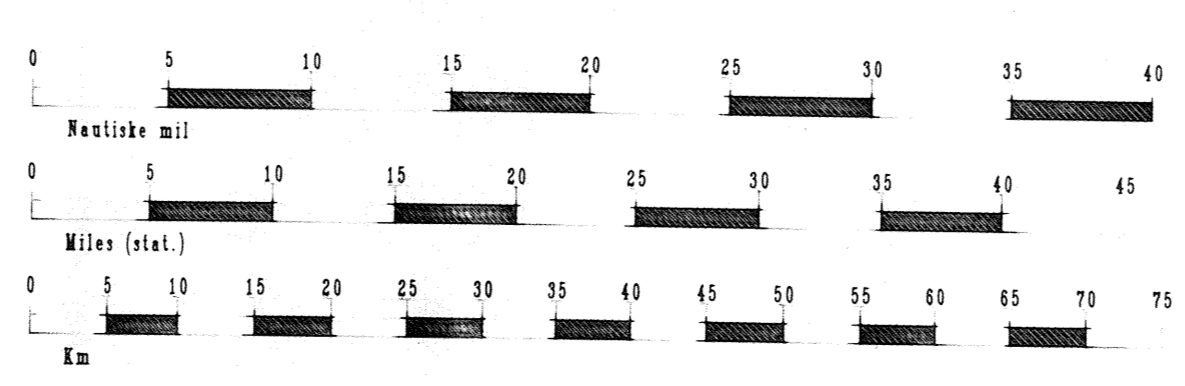

SKALA 1: 500.000



OLJEDIREKTORATET
 NORWEGIAN PETROLEUM DIRECTORATE

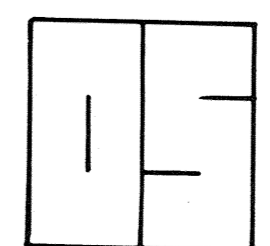

ORKUSTOFNUN
 NATIONAL ENERGY AUTHORITY

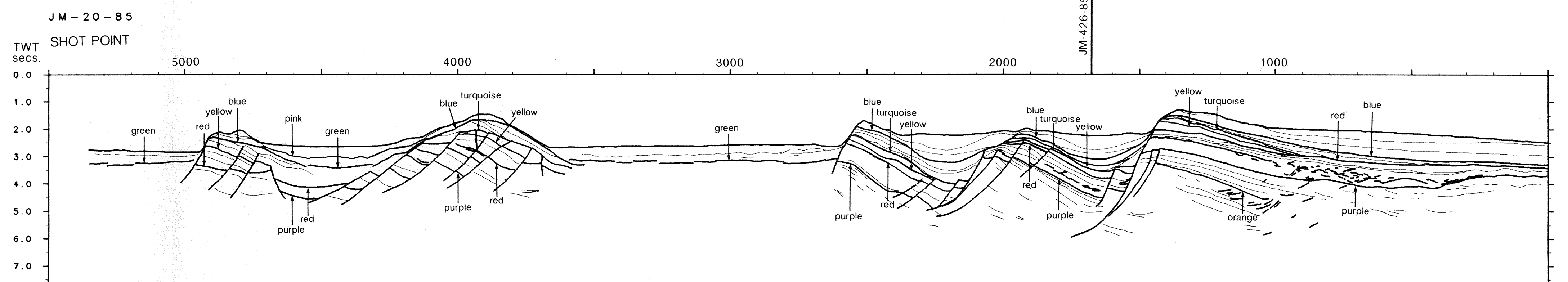
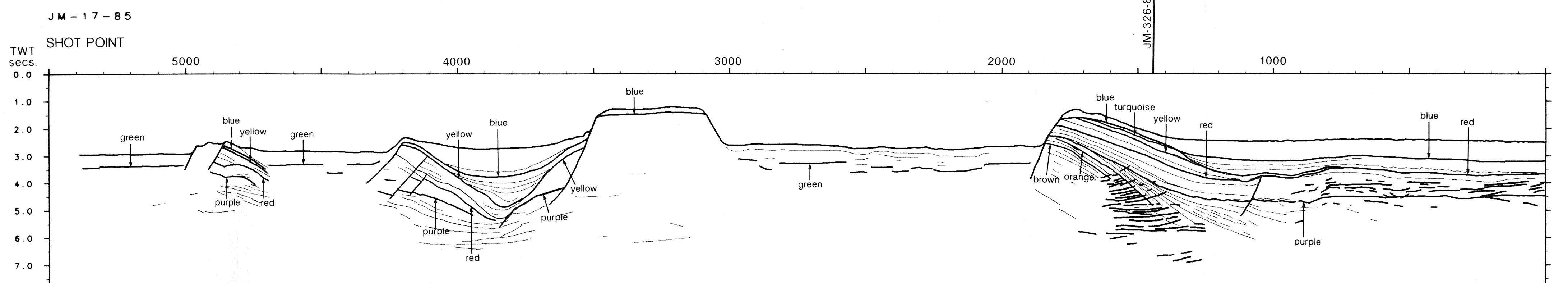
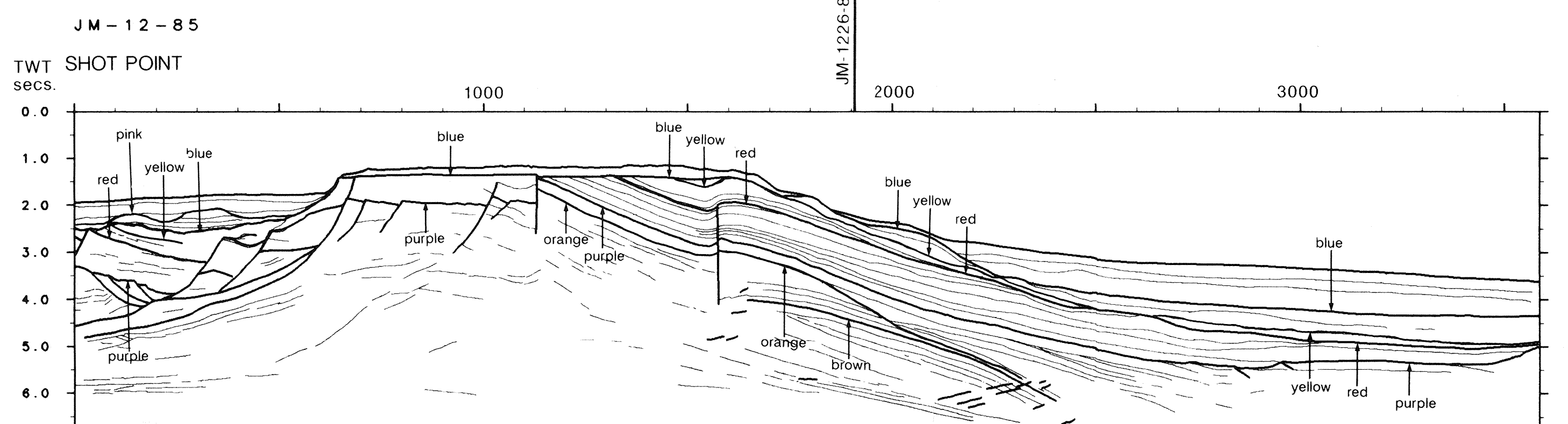
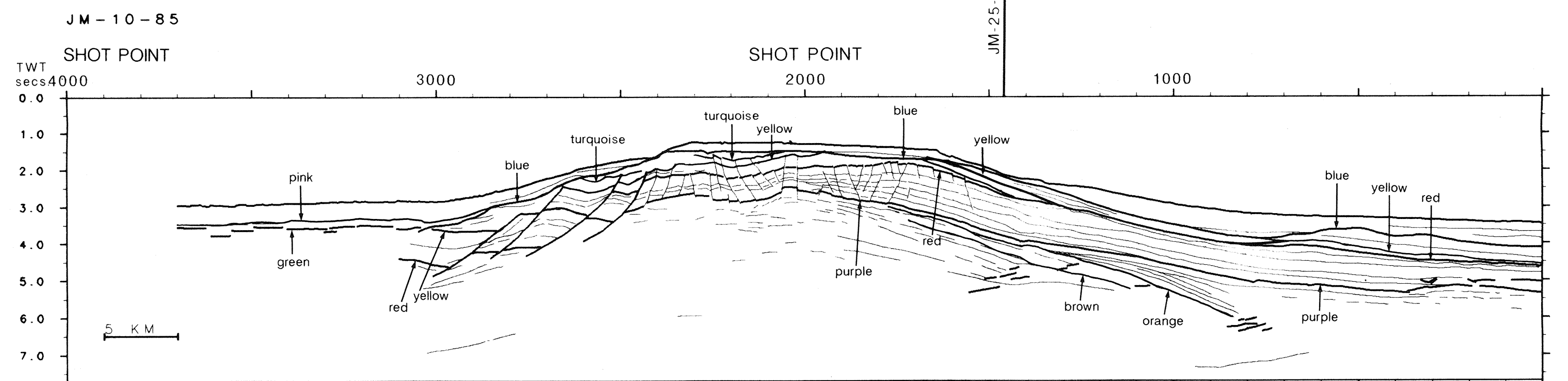
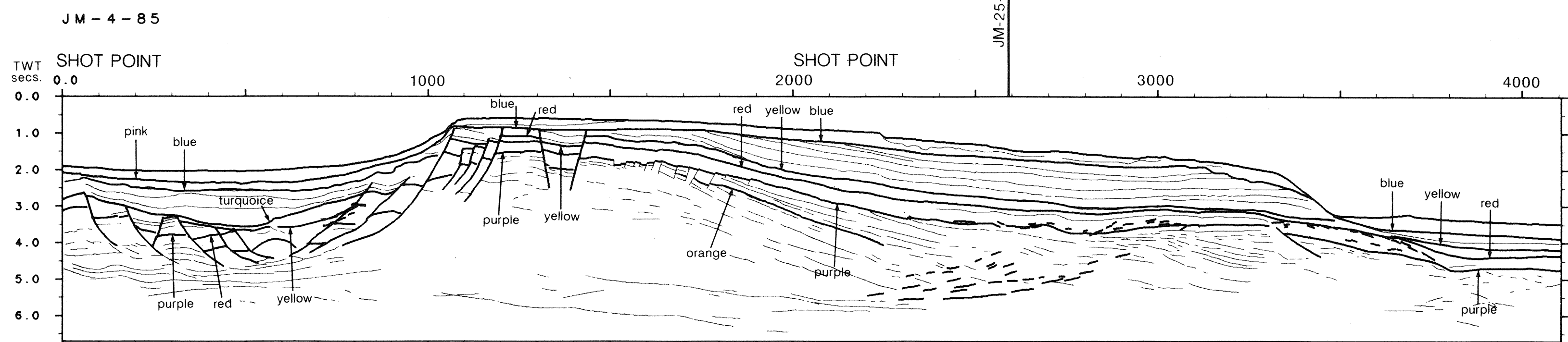
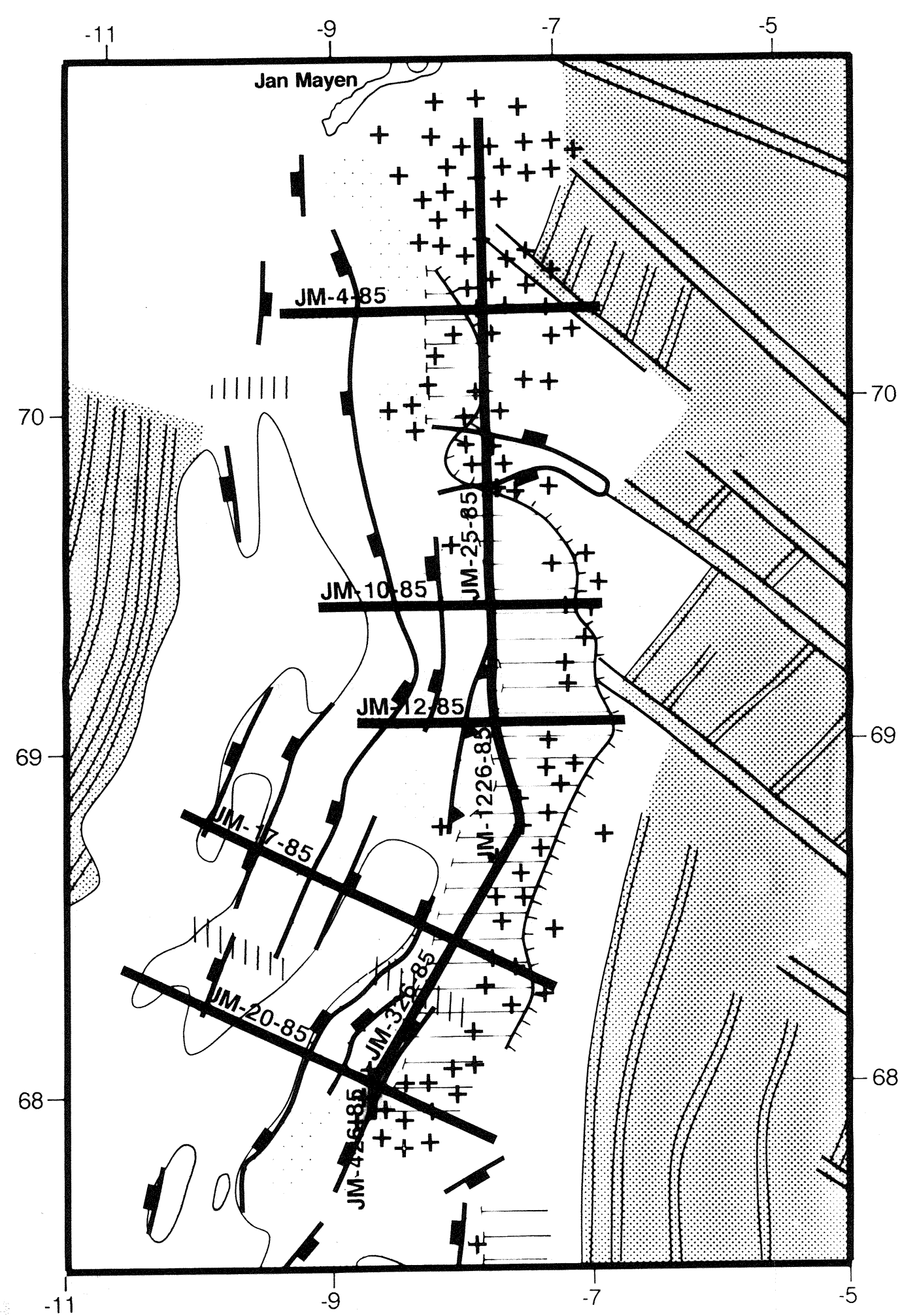

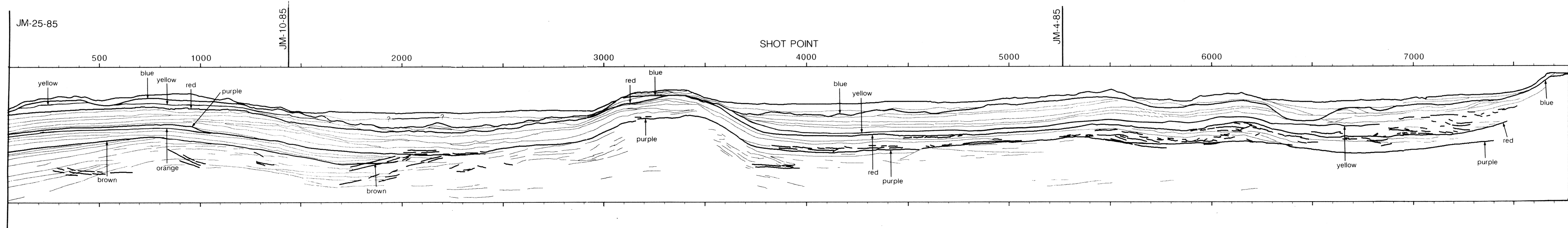
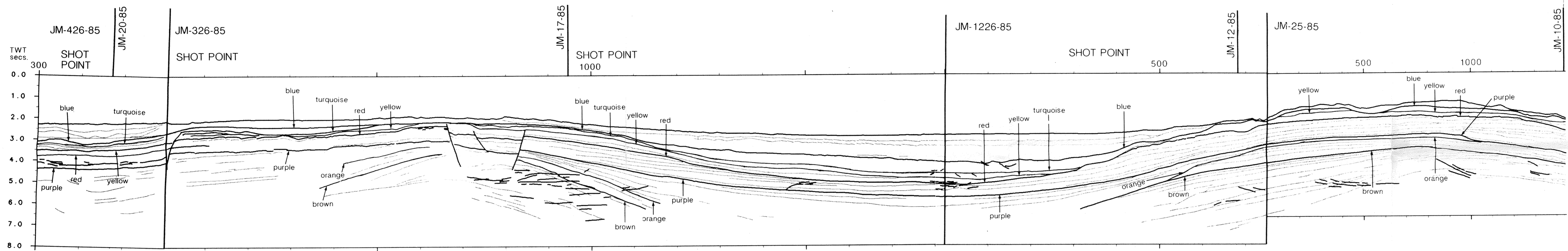

PRESENT

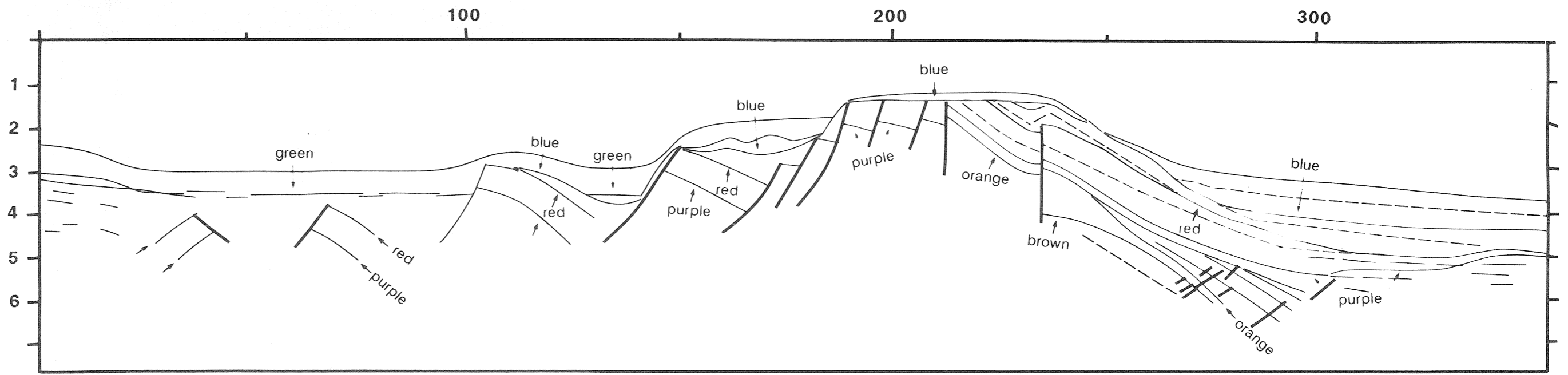

ANOMALY 6A (21 Ma)

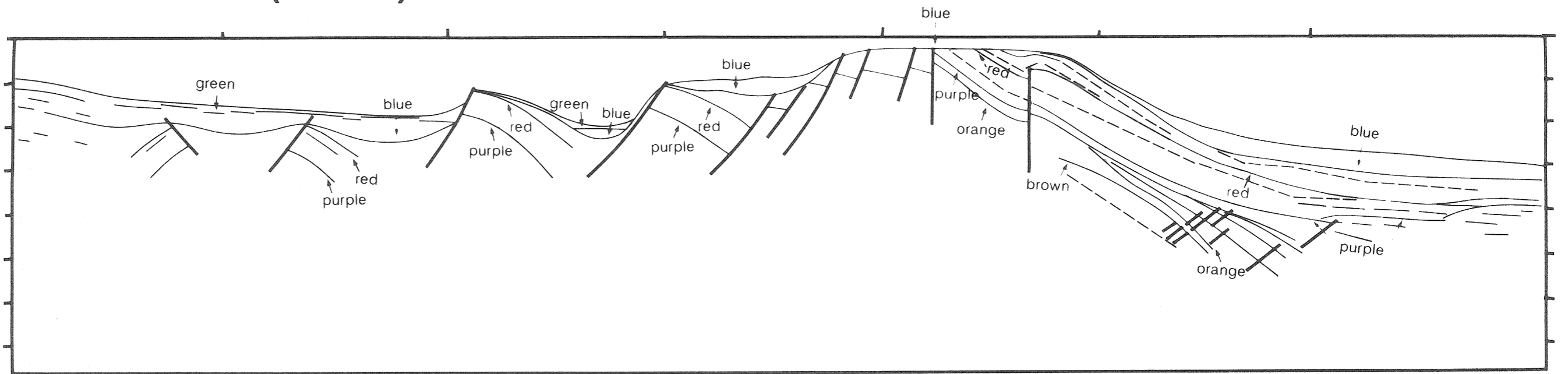

ANOMALY 10 (30 Ma)

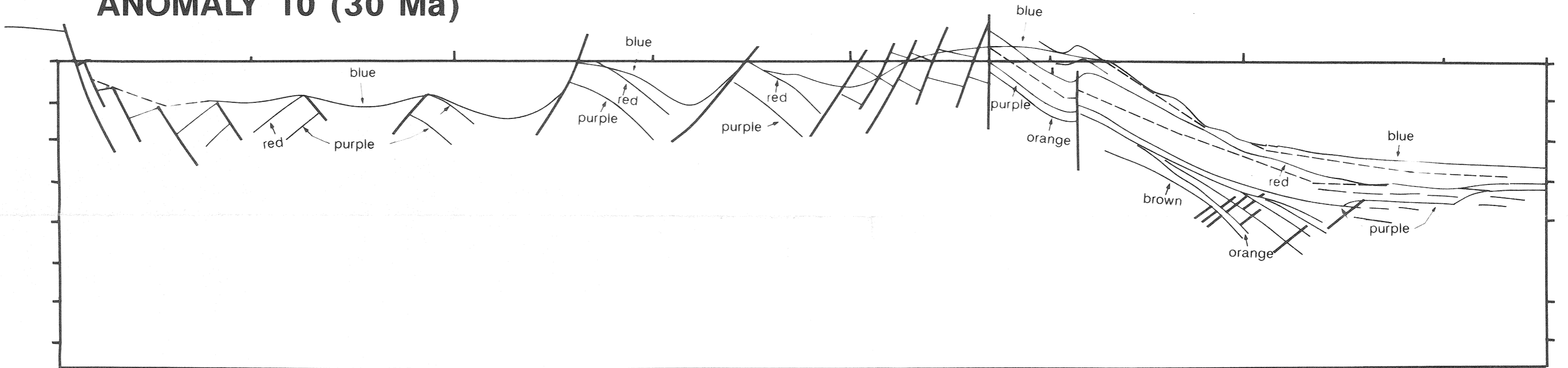

ANOMALY 21 (50 Ma)

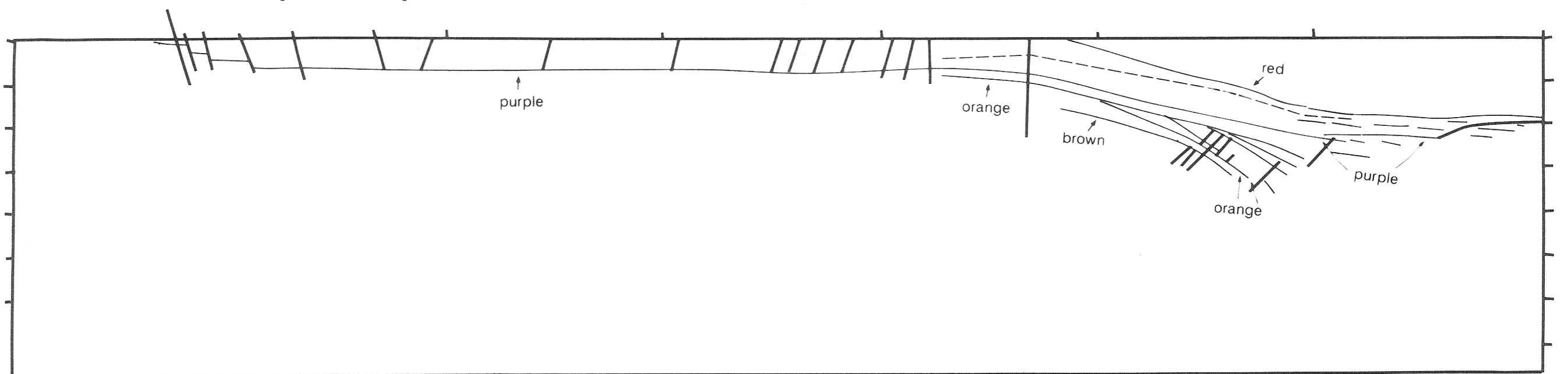

ANOMALY 24 R (57 Ma)

